

# BRITTHERM<sup>®</sup>

## BRITTHERM CIRCULATOR PUMPS

### P5 series

(cast iron volute pumps with 10 programs  
and remote control function)



636199

INSTALLATION AND  
OPERATION MANUAL

# Table of Contents

General Information.....	03
Product Description.....	04
Pump Operation.....	05
Program Control.....	06
Package/Installation.....	08
Pump Maintenance.....	12
<b>Appendix (Specifications).....</b>	<b>12</b>
<b>Appendix (Malfunctions).....</b>	<b>19</b>
Warranty.....	20

## WARNING SIGNS



General safety warning



Shock hazard



Injury hazard



Thermal hazard (burns)



General warnings or recommendations



### PLEASE READ DETAILED INSTRUCTIONS.

Only qualified and licensed engineers should install the pump. If you do not have an engineer to install and operate the pump, we strongly recommend contacting the local engineer or visit us at [www.brittherm.co.uk](http://www.brittherm.co.uk) or call us on 0208 9044 832.

You should carefully read the instructions and specifications of the pump, purpose and recommendations for pump operation before changing the pump operation mode (speed). The best way is to contact the engineer who installed the pump for you and consult with him on the issues in which you are interested.

Once the installation has been completed and the pump has been commissioned, you have 30 calendar days to register your warranty at <https://www.brittherm.co.uk/guarantees> by scanning the QR code that you see on the pump nameplate. To complete the warranty registration, you will need the following information: pump model, invoice number, purchase/installation date, name and email address of the owner, and address where the pump is fitted. Please see the last page for the warranty information.



In case of any anomalies that you observed in the pump operation, you should contact the engineer who installed the pump for you and consult with him. Do not try to disassemble and troubleshoot the pump yourself. This can be a life-threatening activity.

## **PRODUCT DESCRIPTION**

The P5 series pump is a new development of our plant in 2023. P5 pumps are designed specifically for HVAC applications, from boilers and heat pumps to HIU- a heat interface unit systems. Each P5 series pump has two unique functions iPWM GT and iPWM ST for remote control of its operation, for use in complex systems such as solar heating, clustered operation with heat pumps, operation in boiler rooms, with a large number of consumers, etc.

The motor of P5 pumps is made on technology of compact rotor with permanent magnets, which ensures quiet operation and low power consumption, meets the most strict ErP regulations, and has  $EEL \leq 0.17 \sim 0.23$ . The automation of these pumps has 10 automatic operation modes and these pumps can also be used in any domestic heating system, including underfloor heating systems, cooling and air conditioning systems, solar and geothermal energy systems, for clean water recycling and pumping, if its specifications meet the specified parameters of such systems.

Intelligent operation modes of P5 series pumps automatically adjust to the specifications of any heating system in order to achieve optimal comfort and minimum energy consumption, i.e. to achieve the best effect for any closed heating system and for any goals. P5 series pumps do not require maintenance during the entire service life that confirms their high reliability, which is why we successfully offer our customers a 6-year warranty for these pumps.

## **It is suitable for:**

- Domestic heating systems
- Heating systems using HIU
- Radiator heating
- Underfloor heating
- Non-potable water recirculation
- Cooling systems
- Air conditioning systems
- Solar heating systems
- Heating systems using heat pumps

The pump design consists of a motor and a pump body. The cast iron volute pump casing (pump volute) has a cathaphoretic coating that acts as a protective layer providing ten times greater corrosion resistance than untreated cast iron.

The electric glandless pump motor provides lubrication of bearings and cooling by the pumped fluid.

An aluminium alloy body reliably protects motor windings. The pump body is ventilated to prevent condensation and corrosion.

The power cable is connected using spring-loaded electrical clamps in the pump terminal box with IP44 level protection.

The pump is mounted using coupling nuts.

## **PUMP OPERATION**



Make sure that the heating system is filled and under the required pressure before turning on the pump. Pump operation without the pumped fluid can damage the pump. Warranties do not cover such damage.

Make sure that the pump is installed correctly, check the direction of the required fluid flow, check that there are no fluid leaks at the pump and pipe connections.

Check the correct connection of the electrical cable - phase, zero and ground.

Make sure that the valves upstream and downstream of the pump are open.



Energise the pump. The pump operation and rotor rotation direction should be checked using special instruments - rotation indicators, which the engineer must have. The pump should run quietly. Bleed air as through air vents at top system points, if extraneous noises appear.



Pump operation characteristics in all modes are indicated in Appendix I thereto.

## PROGRAM CONTROL

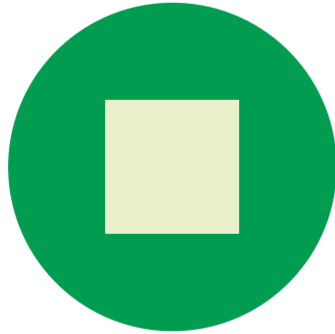

	i PWM switch button	Short press to switch iPWM GT and iPWM ST
	working mode switch button	Short press to switch the working modes in turn

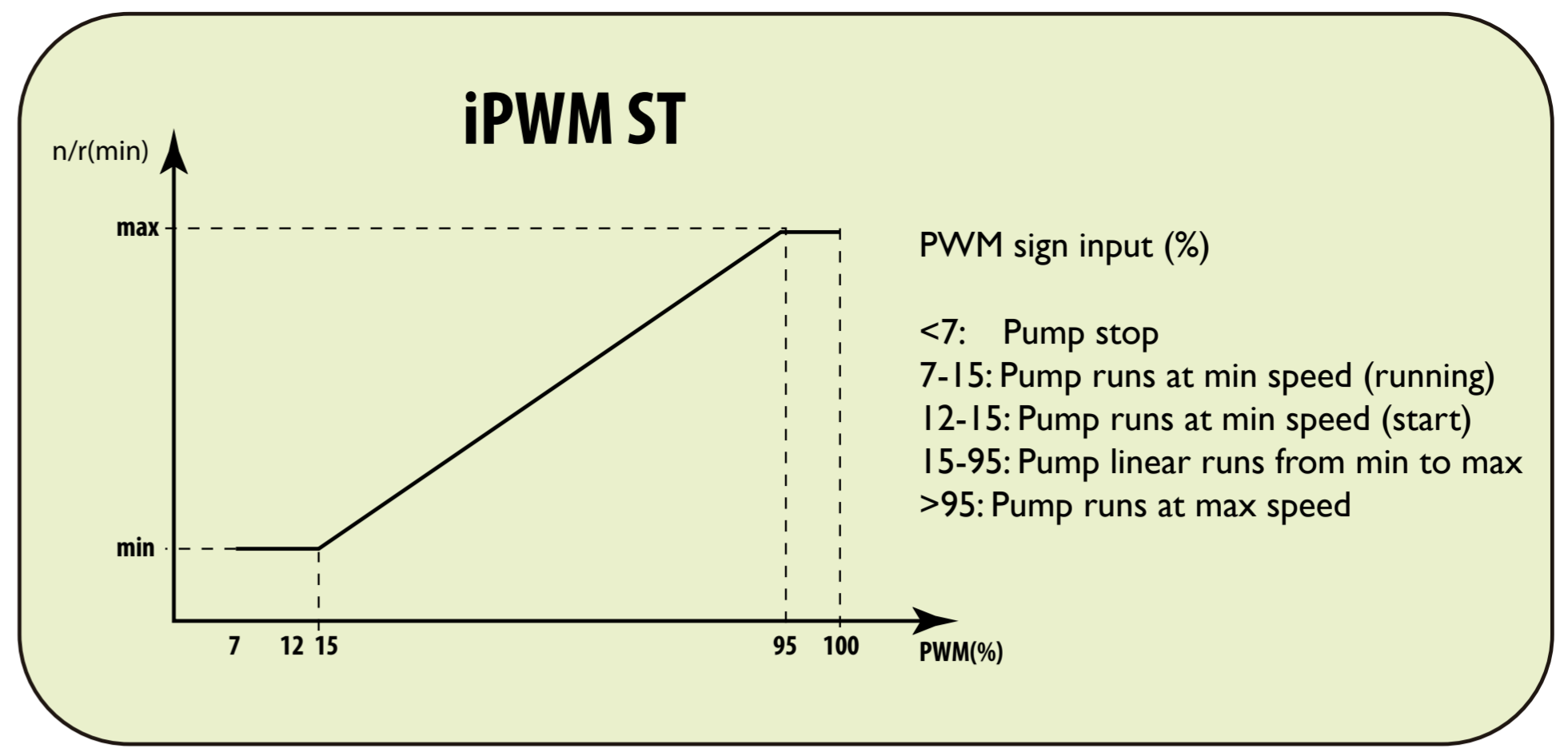
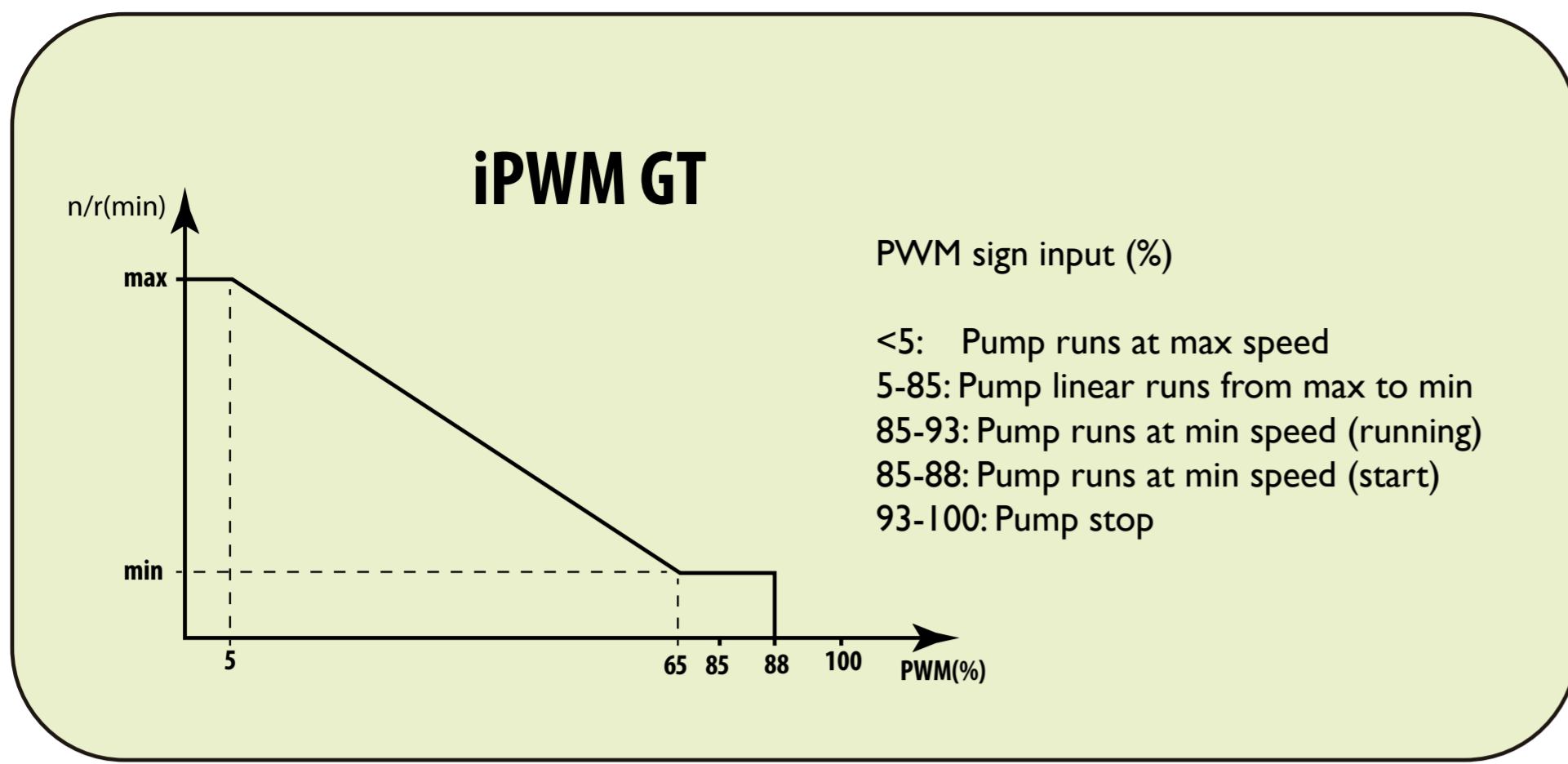

	Third speed working indicator light	On Manual third speed fixed speed work
	Second speed working indicator light	On Manual second speed fixed speed work
	First speed working indicator light	On Manual first speed fixed speed work
	Auto working indicator light	The pump automatically adjust the power according to the water flow under this mode.
	Max Proportional Pressure indicator light	Under this mode, the pump runs at the max proportional ratio, that is, the larger the flow, the higher the head.
	Min Proportional Pressure indicator light	Under this mode, the pump runs at the min proportional ratio, that is, the larger the flow, the higher the head.
	Max Constant Pressure indicator light	Under this mode, the pump runs at the max constant pressure, that is, no matter how the flow changes, the head always remains constant.
	Min Constant Pressure indicator light	Under this mode, the pump runs at the min constant pressure, that is, no matter how the flow changes, the head always remains constant.
	Power indicator light	Display the actual working power when pump is working.
	iPWM GT indicator light	Pump working under iPWM GT mode
	iPWM ST indicator light	Pump working under iPWM ST mode

## PACKAGE

- Pump assembly - 1 piece;
- Set of coupling nuts with gaskets - 1 set;
- Thermal insulation foam jacket - 1 piece;
- Power cable, 1.3m long, with plug (UK) - 1 set;
- Control cables (2 pieces);
- Installation and operation manual - 1 piece;
- Individual packaging - 1 piece.

Full specifications are given in Appendix I thereto.

## INSTALLATION

Figures of pumps are given for understanding the installation rules and may differ from the actual products.



Pumps should be installed by personnel who have a permit to work with electrical equipment, trained and have sufficient experience in operating similar pumping equipment!

Check the completeness, absence of mechanical damage on the pump, nuts, electric cable and electric plug before installation.

The pump motor, during installation, should always be placed parallel to the horizontal surface relative to the floor in the room.

The correct layout of the pump is shown in Fig. 2 and 3.

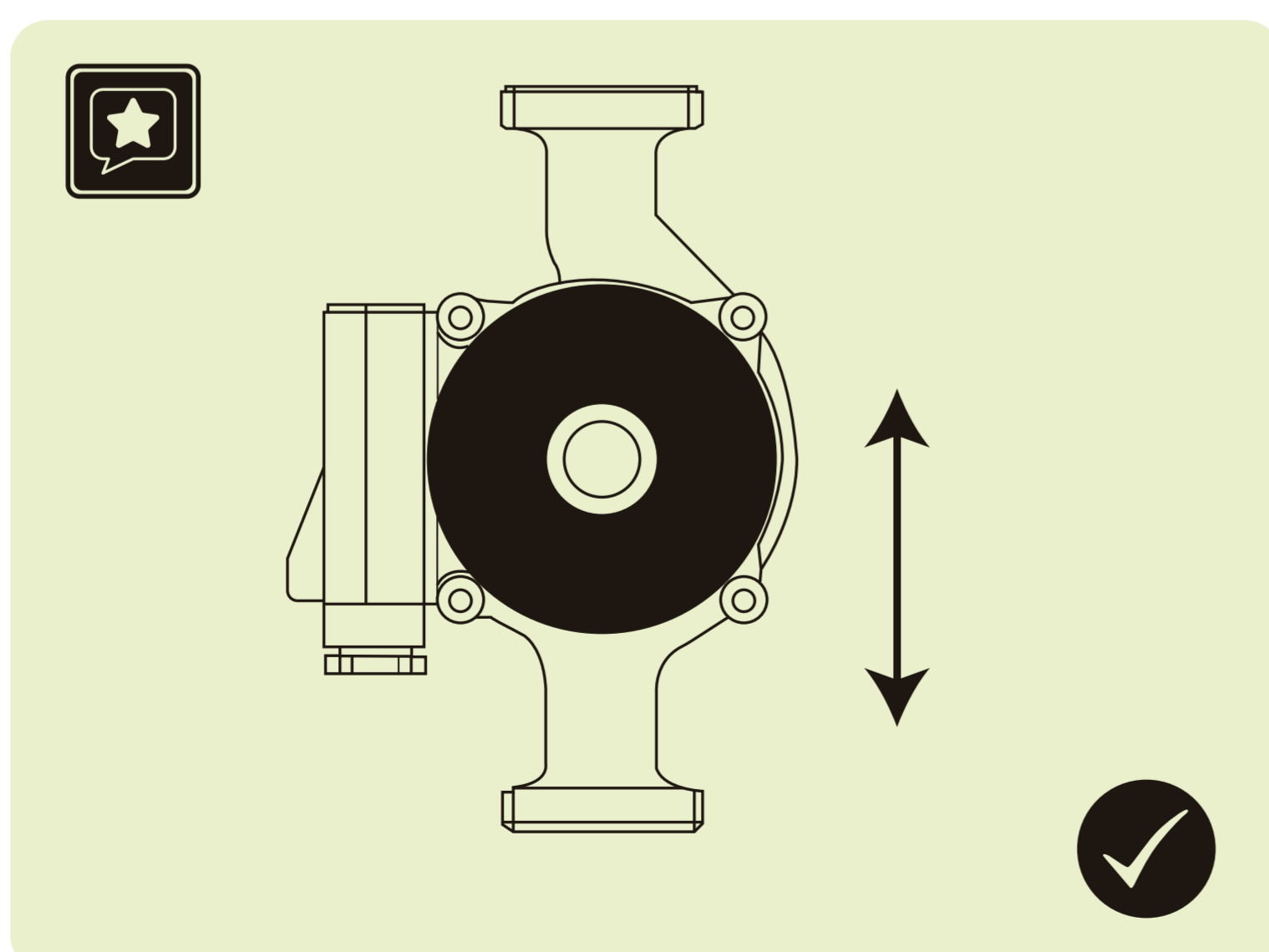

Fig. 2

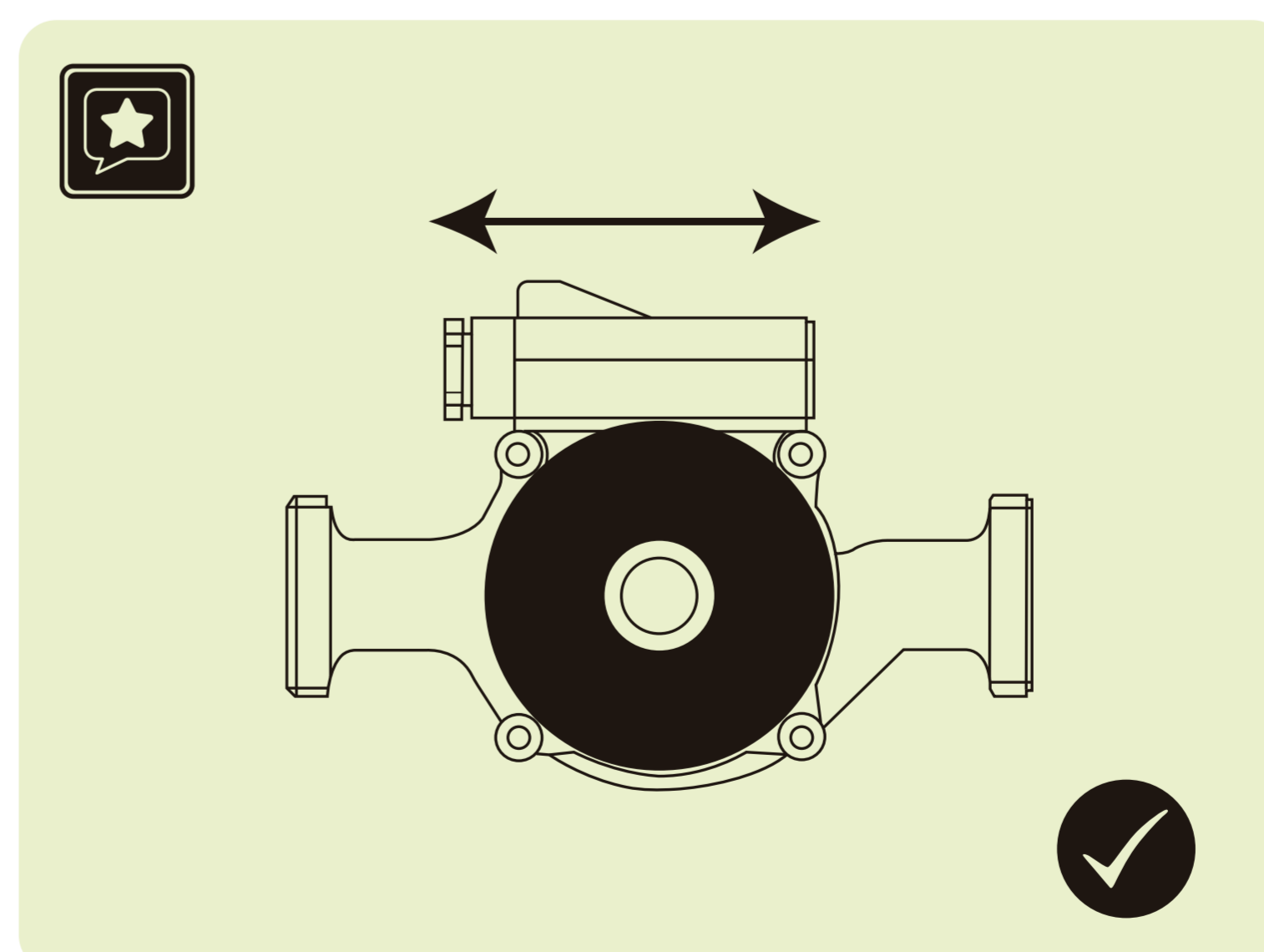

Fig. 3



Incorrect layout of the pump is shown in Fig. 4 and 5.

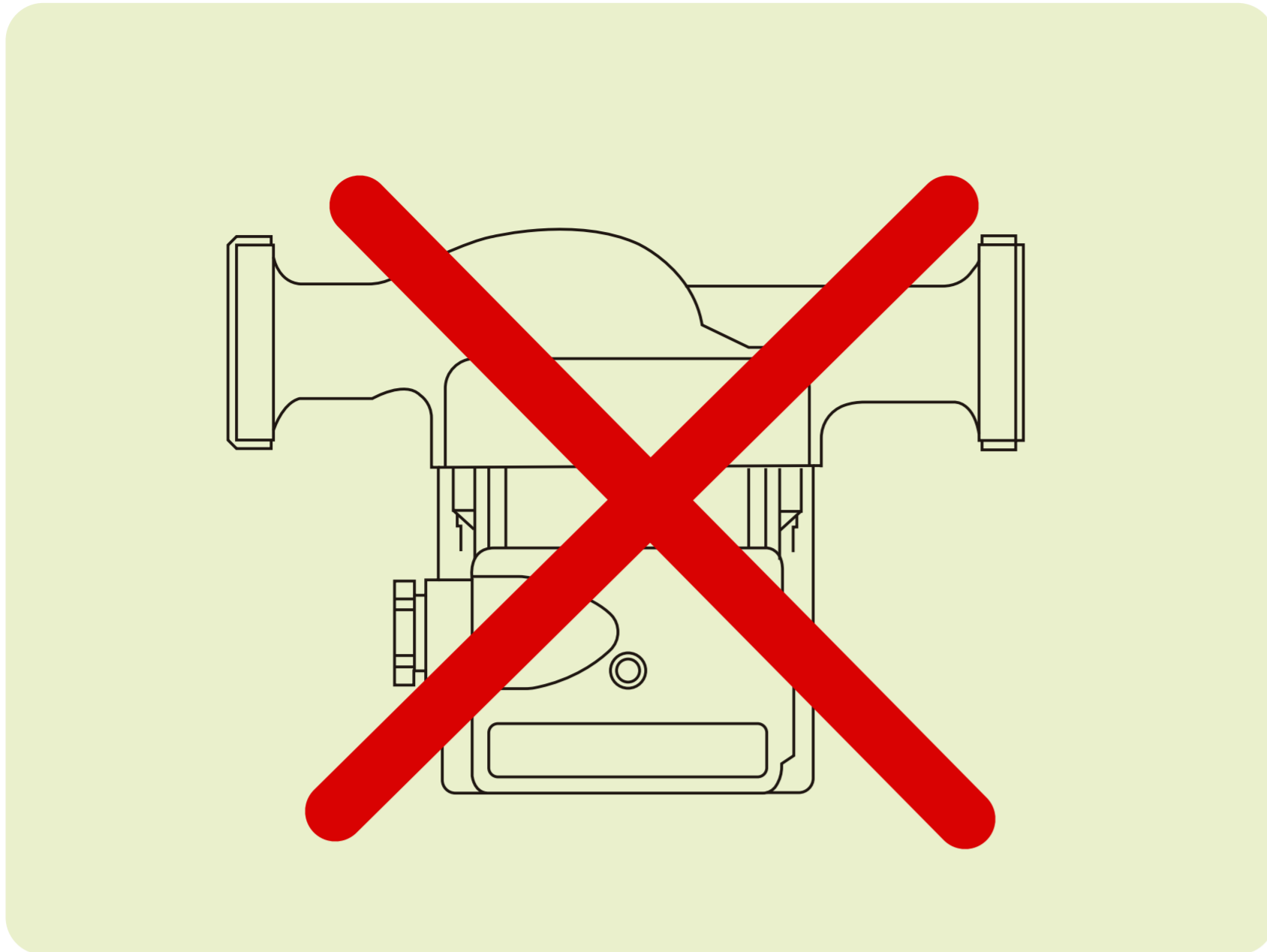

Fig. 4

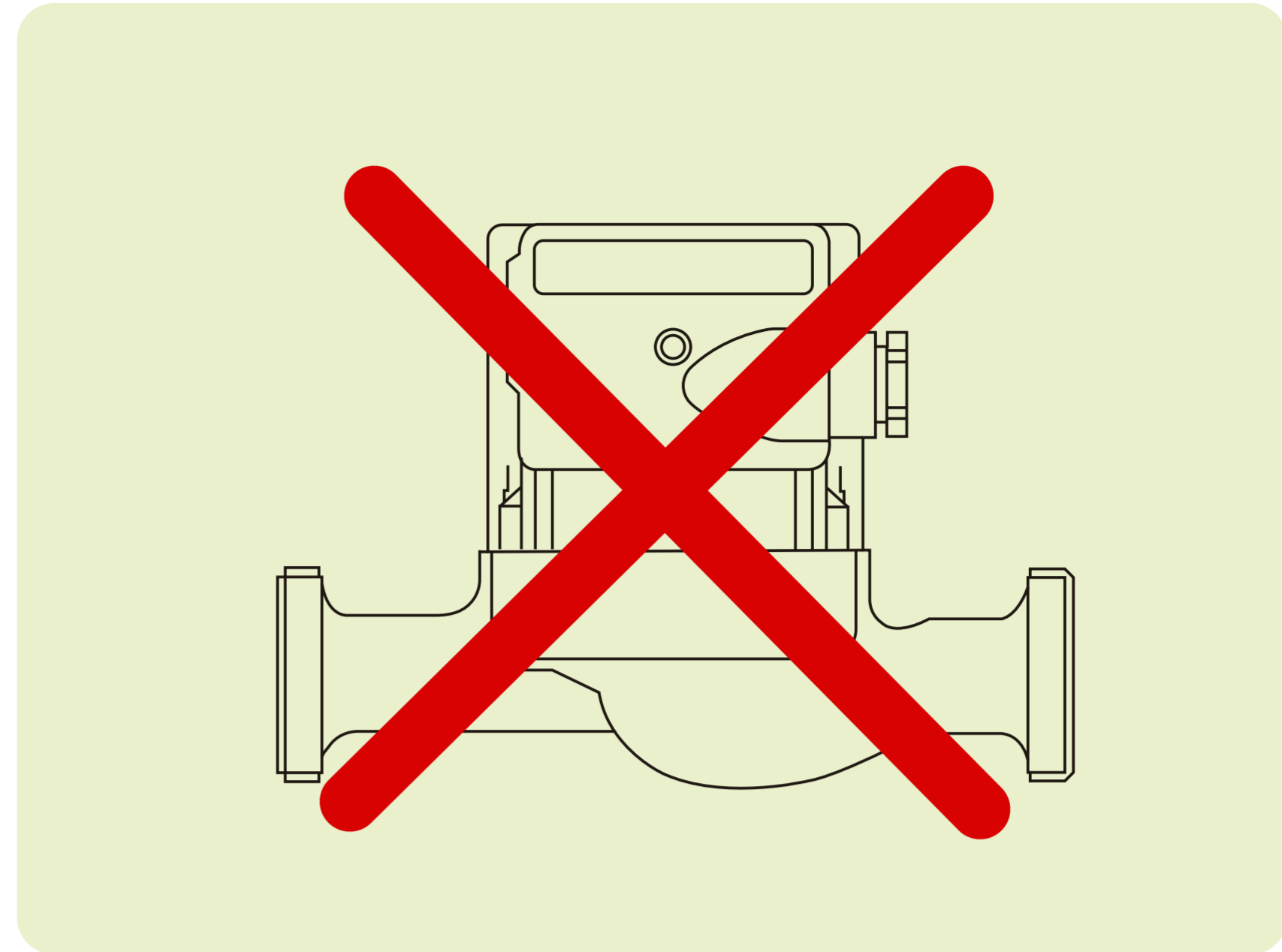

Fig. 5

Do not position the pump casing with the terminal box down, Fig. 6

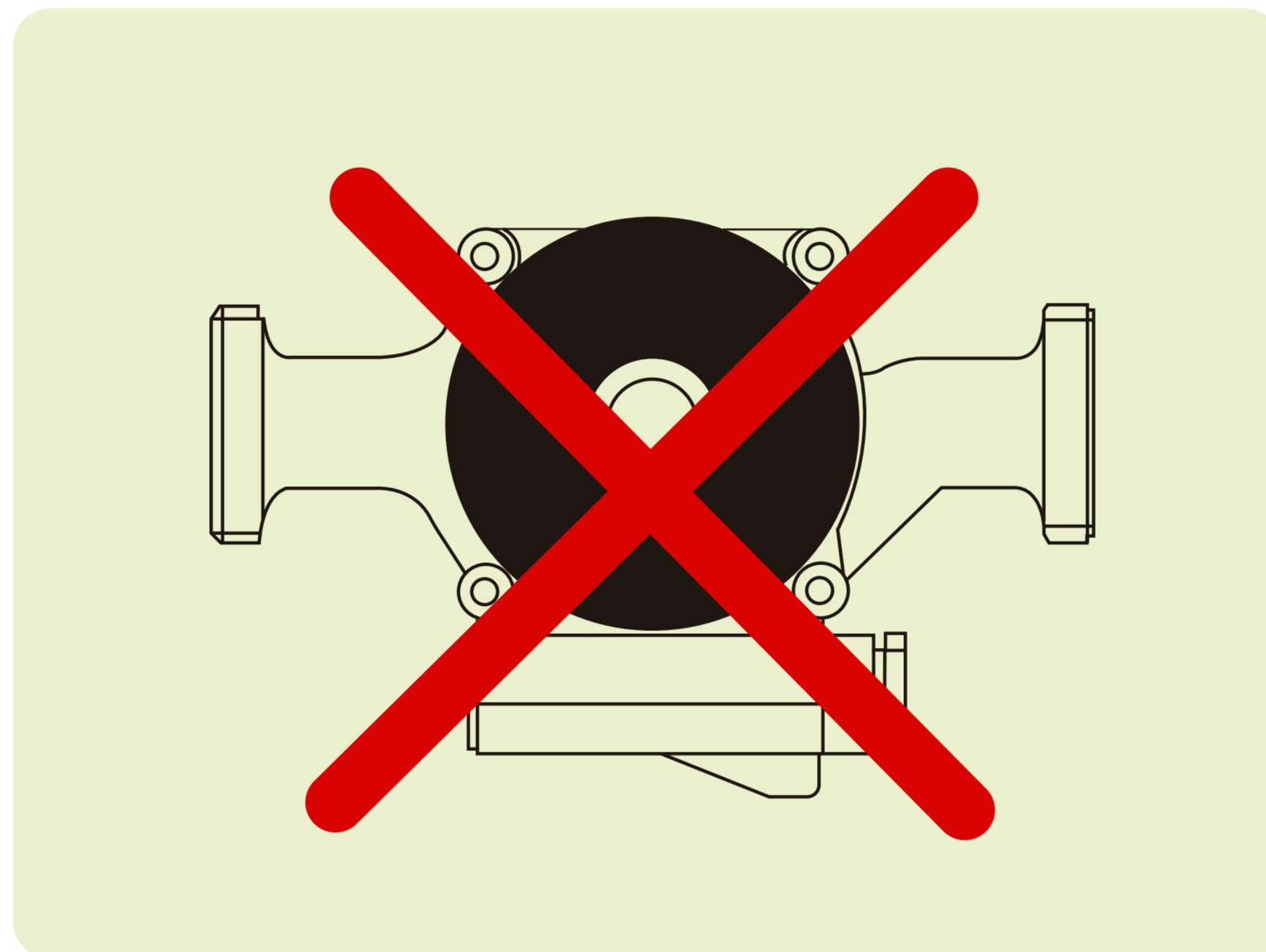

Fig. 6

Permissible layout of the pump and terminal box are shown in Fig. 7

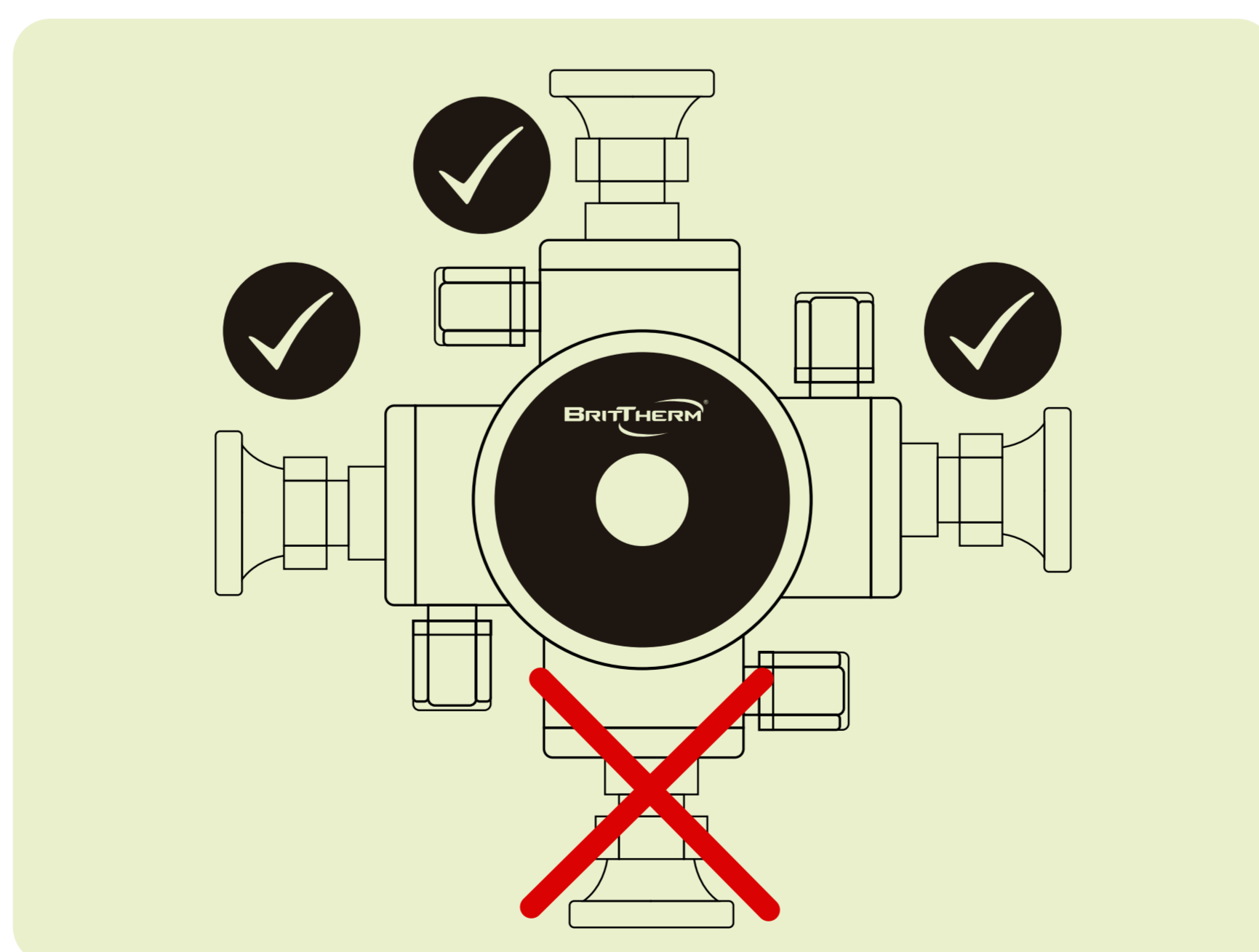

Fig. 7

It is recommended to install shut-off valves upstream and downstream of the pump as shown in Fig. 8.

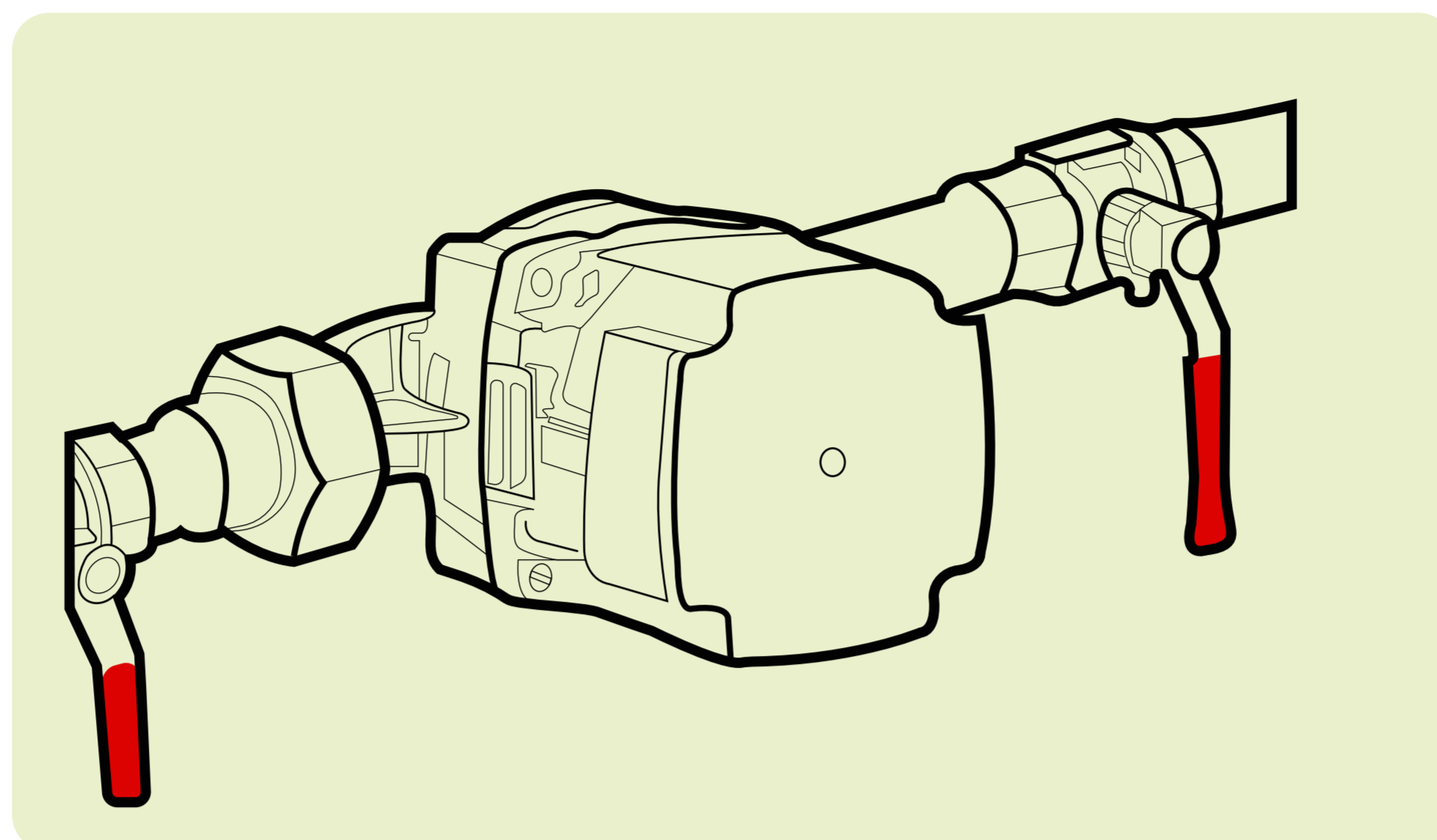

Fig. 8

If necessary, you can change the layout of the pump motor relative to the volute by 90-180-270 degrees. To do this, it is enough to unscrew the four screws securing the motor, rotate the body in 90-degree pitch and tighten the screws, as shown in Fig. 9.



To perform this procedure, it is necessary to close the valves upstream and downstream of the pump, turn off the power supply and prepare a container for fluid. Water will flow from the pump after unscrewing the screws. Once the pump is in position, tighten the screws evenly and crosswise. Open the valves to the system. Air from the pump should be removed through air vents installed at the top points of the system.

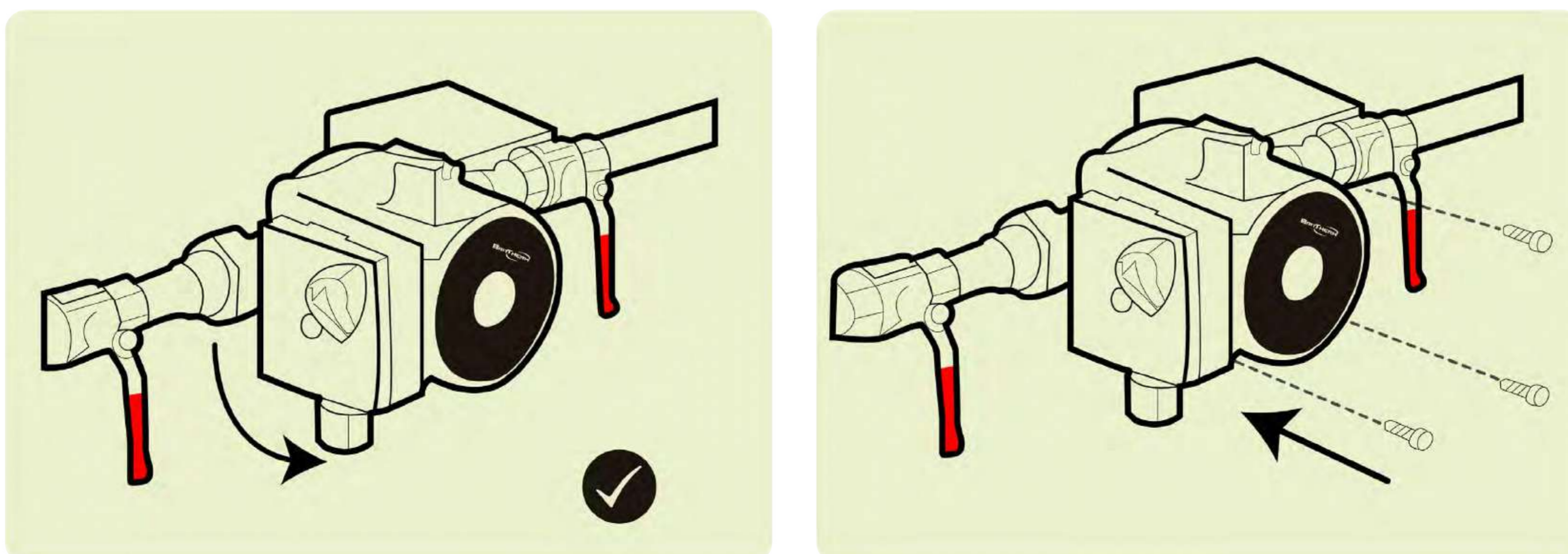

Fig. 9

Use coupling nuts and gaskets to mount the pump, Fig. 10.  
Use special or universal wrenches of the appropriate size.  
Do not overtighten the nuts as this may damage the rubber seals.

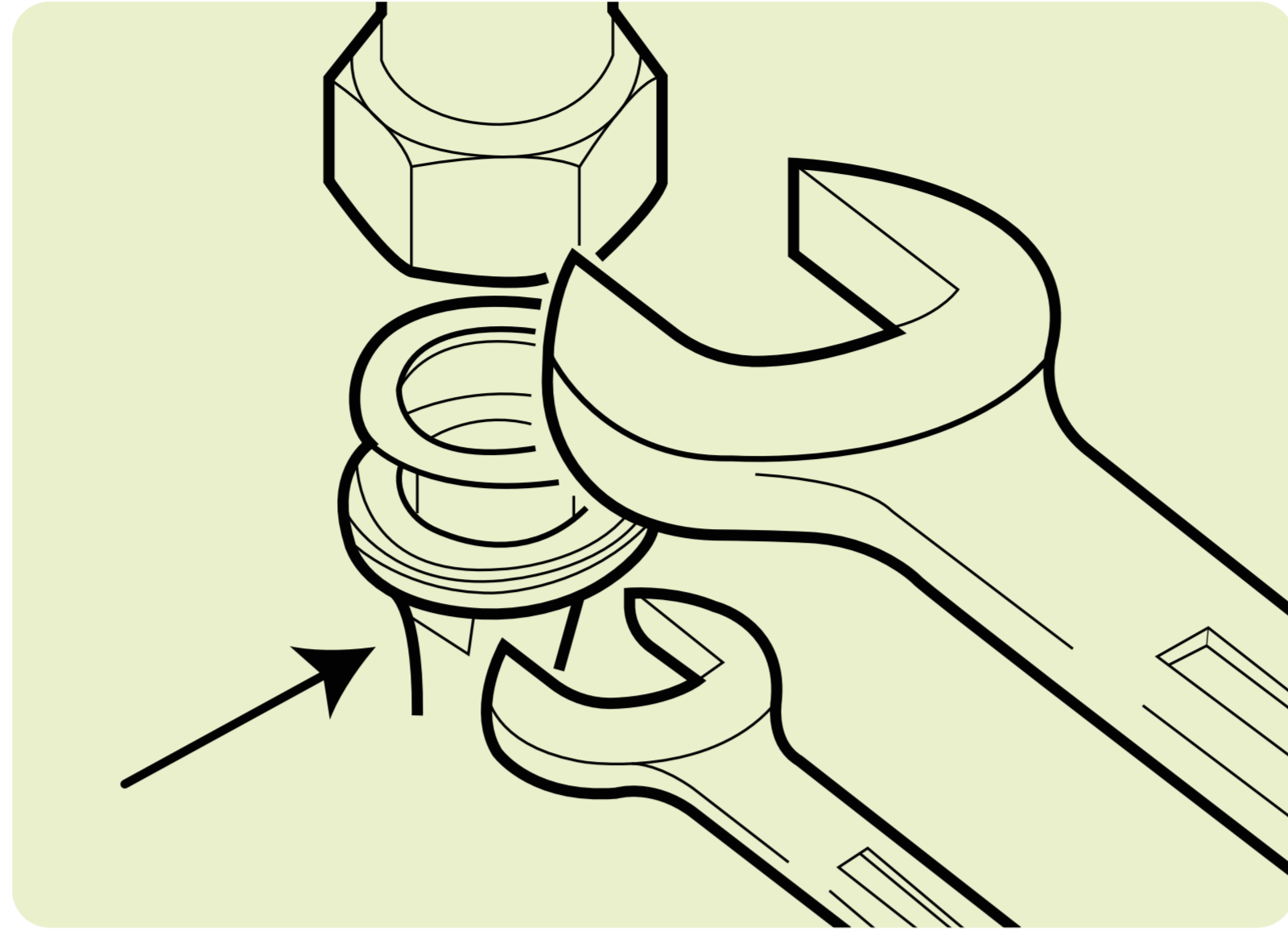

Fig. 10

The pump installation should be carried out taking into account the possibility of its replacement and maintenance. Always use new seals when replacing or installing the pump in a new place.



The P-Series pump uses a quick release connector. Just connect the power cable to the connector. See Fig. 11.

Brown - to terminal L (phase);  
Blue - to terminal N (neutral);  
Yellow-green - to terminal  $\oplus$  (ground).

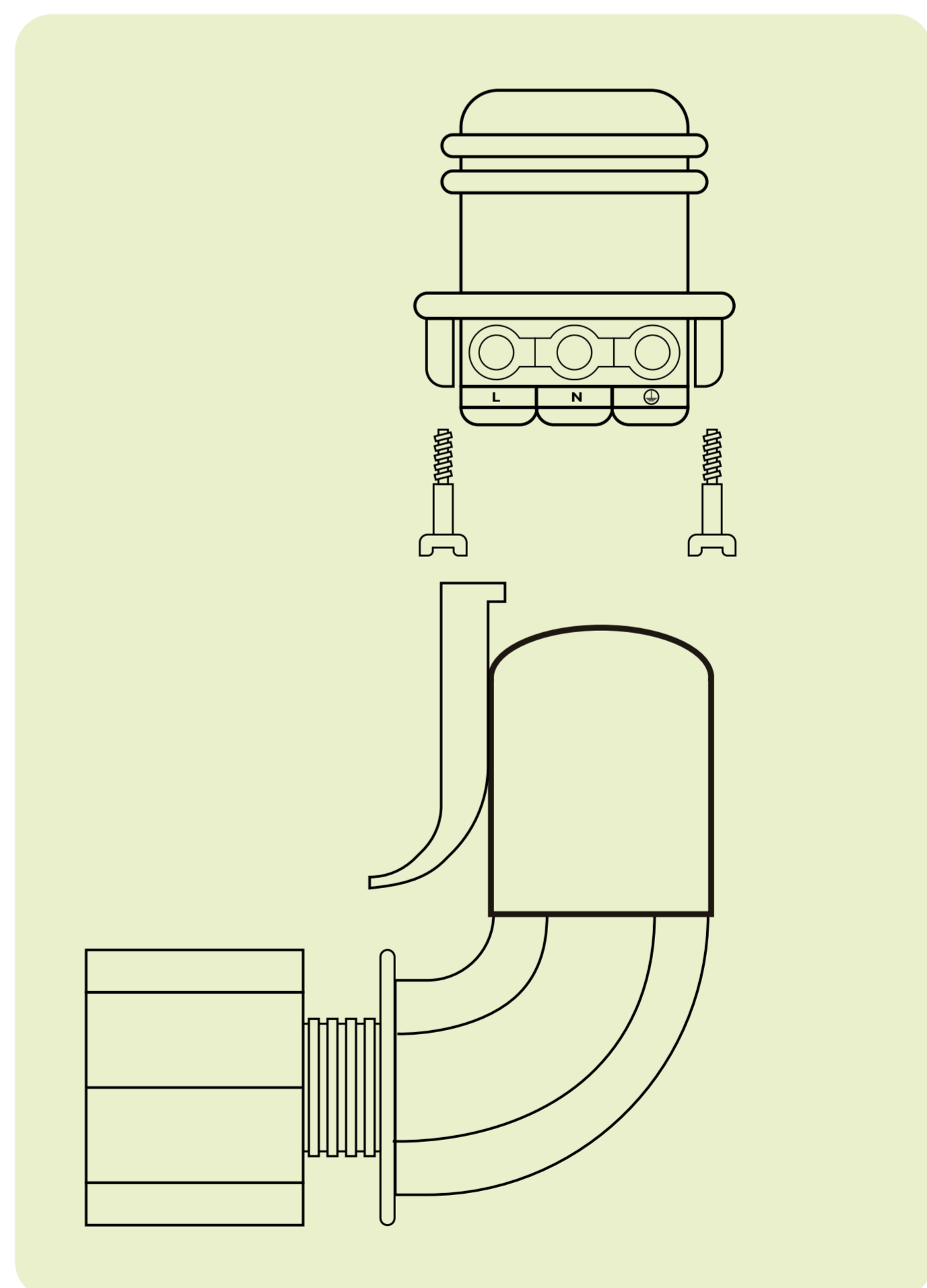

Fig. 11

Wire with plug is supplied complete with the product.  
Be sure to check the compliance of the mains voltage at the site and on the pump nameplate marking. The use of grounding is a prerequisite for ensuring the electrical safety of the equipment, as well as the safety of people in this room and in rooms nearby.

# PUMP MAINTENANCE

The pump structure is designed in such a way that it does not require special maintenance throughout the entire period of its operation.



It is recommended at least once every 6 months to check for fluid leaks at connections, for damage of the supply cable.

The pump should always run with a full system. Bearings are lubricated and pump is cooled by the pumped fluid.

## APPENDIX I

### P5 SERIES PUMPS SPECIFICATIONS



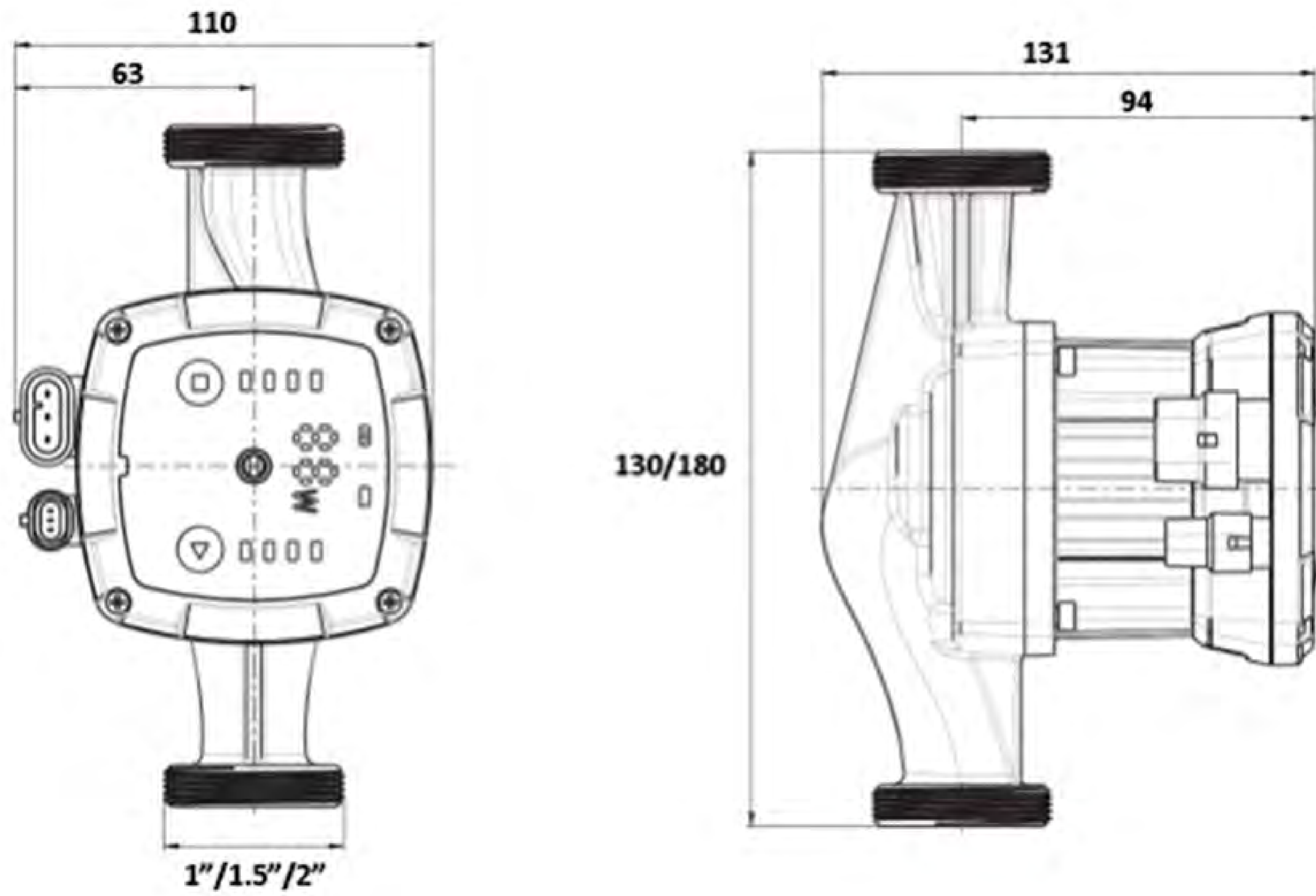

Nº	Code	Model	EEl ≤	Max. Head (meter)	Max. Flow (meter <sup>3</sup> /hour)	Power (watt)	Pump volute length (mm)	Inlet/Outlet Thread (inch)	Pipe connection (inch)	Weight (kg)
1	661995701	P5 15/4-130	0.23	4	2.2	5~22	130	1"	3/4"	n/a
2	661995702	P5 25/4-130	0.17	4	2.7	5~22	130	1 1/2"	1"	n/a
3	661995703	P5 25/4-180	0.23	4	2.7	5~22	180	1 1/2"	1"	n/a
4	661995704	P5 32/4-180	0.23	4	3.1	5~22	180	2"	1 1/4"	n/a
5	661995705	P5 15/5-130	0.23	5	2.6	5~22	130	1"	3/4"	n/a
6	661995406	P5 25/5-130	0.18	5	3.1	5~32	130	1 1/2"	1"	n/a
7	661995407	P5 25/5-180	0.23	5	3.1	5~32	180	1 1/2"	1"	n/a
8	661995408	P5 32/5-180	0.23	5	3.6	5~32	180	2"	1 1/4"	n/a
9	661995409	P5 15/6-130	0.23	6	3.0	5~45	130	1"	3/4"	n/a
10	661995410	P5 25/6-130	0.20	6	3.6	5~45	130	1 1/2"	1"	n/a
11	661995711	P5 25/6-180	0.23	6	3.6	5~45	180	1 1/2"	1"	n/a
12	661995712	P5 32/6-180	0.19	6	4.0	5~45	180	2"	1 1/2"	n/a
13	661995713	P5 15/7-130	0.23	7	3.5	5~52	130	1"	3/4"	n/a
14	661995714	P5 25/7-130	0.20	7	3.8	5~52	130	1 1/2"	1"	n/a
15	661995715	P5 25/7-180	0.23	7	3.8	5~52	180	1 1/2"	1"	n/a
16	661995716	P5 32/7-180	0.20	7	4.3	5~52	180	2"	1 1/4"	n/a
17	661995717	P5 15/8-130	0.23	8	3.5	5~52	130	1"	3/4"	n/a
18	661995718	P5 25/8-130	0.20	8	4.3	5~52	130/180	1 1/2"	1"	n/a
19	661995719	P5 25/8-180	0.23	8	4.3	5~52	130/180	1 1/2"	1"	n/a
20	661995720	P5 32/8-180	0.21	8	3.9	5~52	180	2"	1 1/4"	n/a

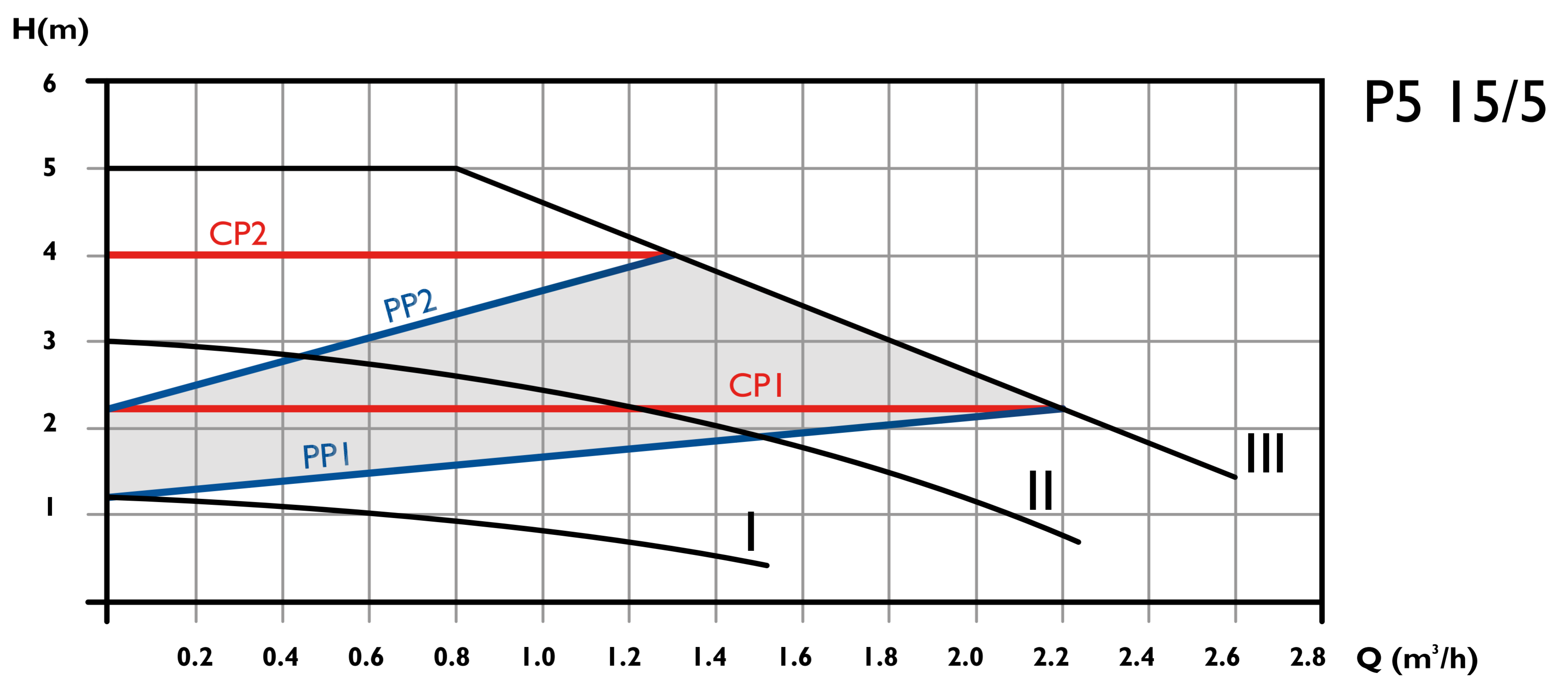
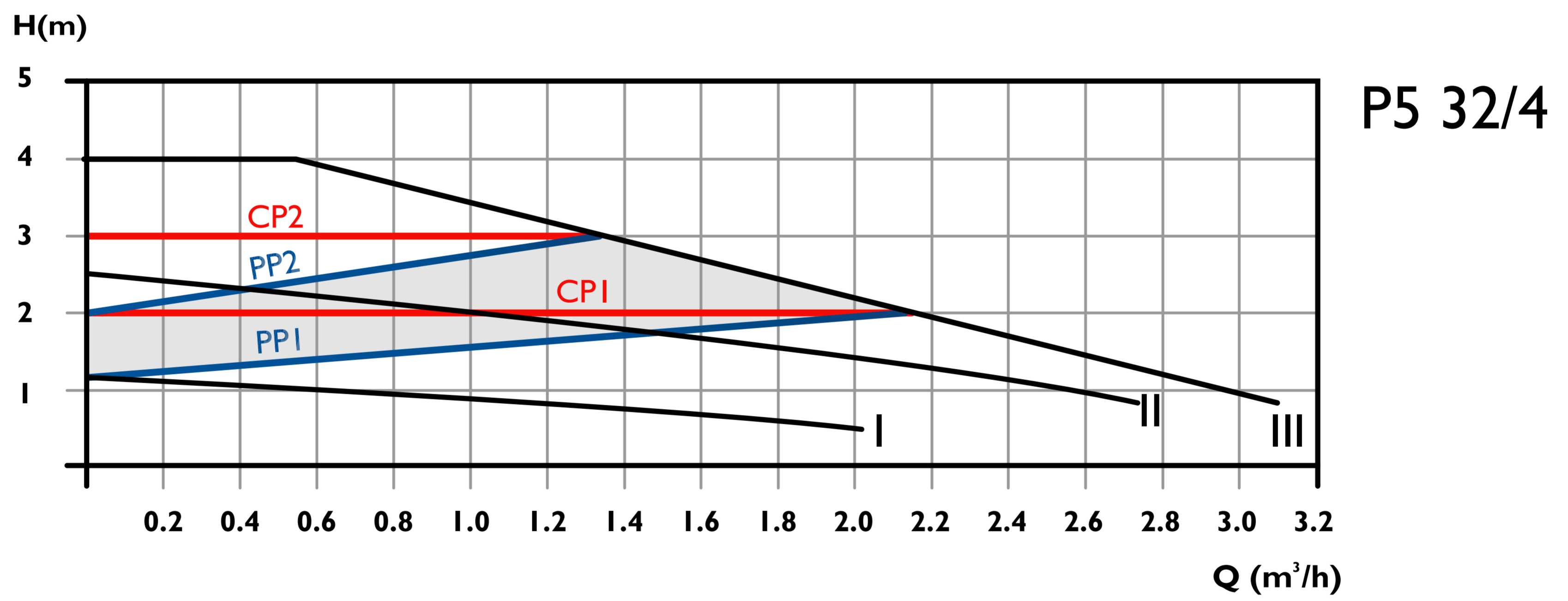
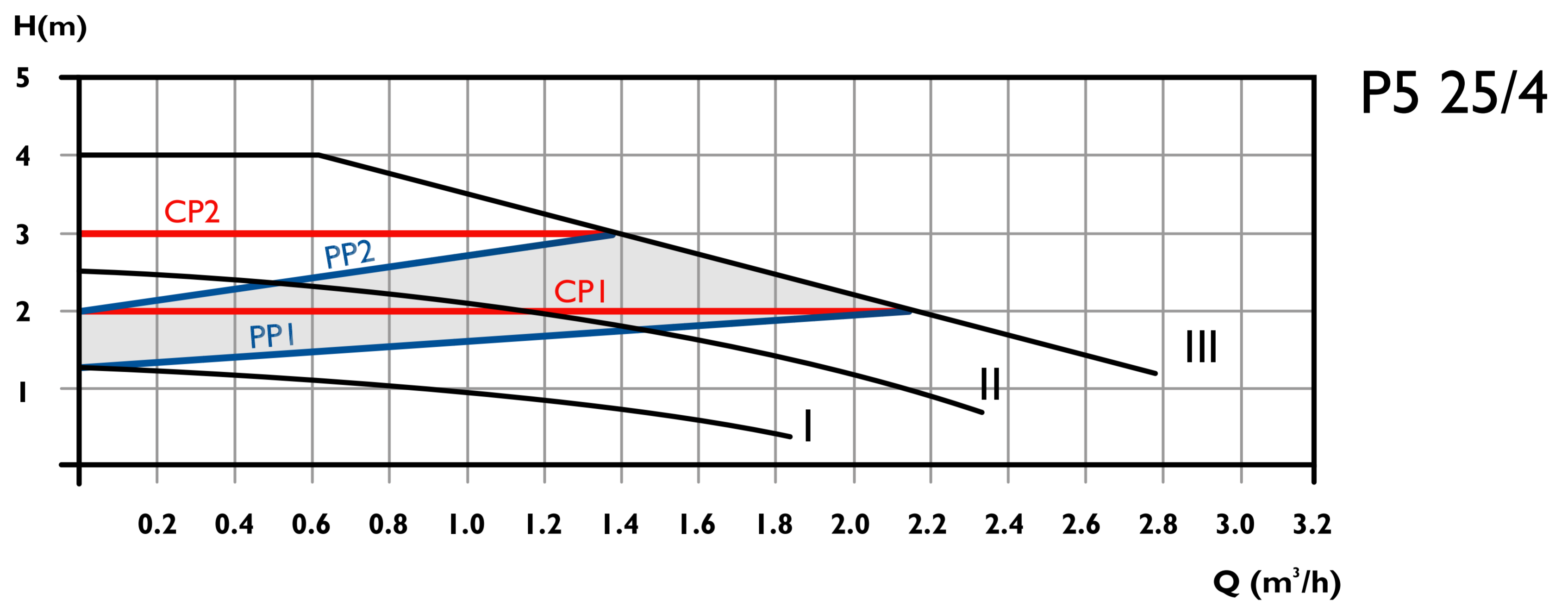
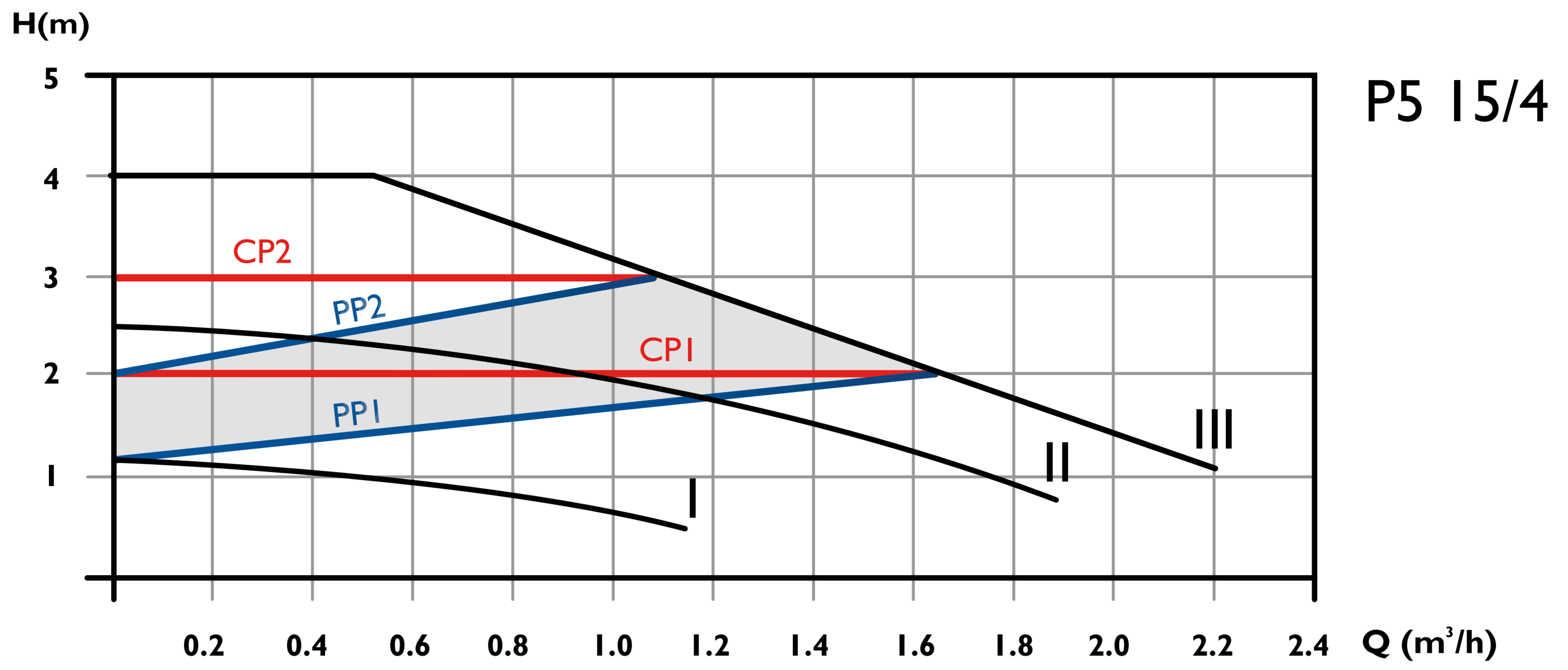

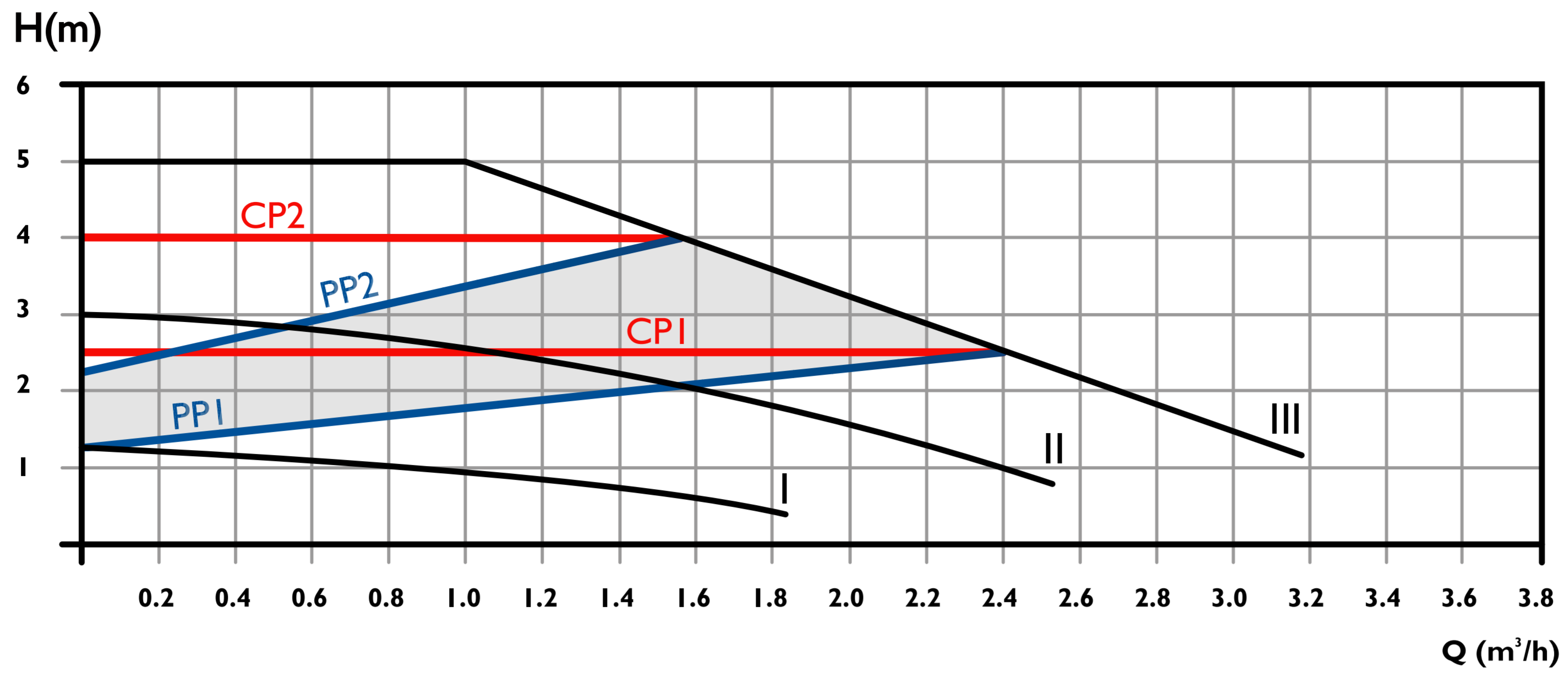

P5 25/5

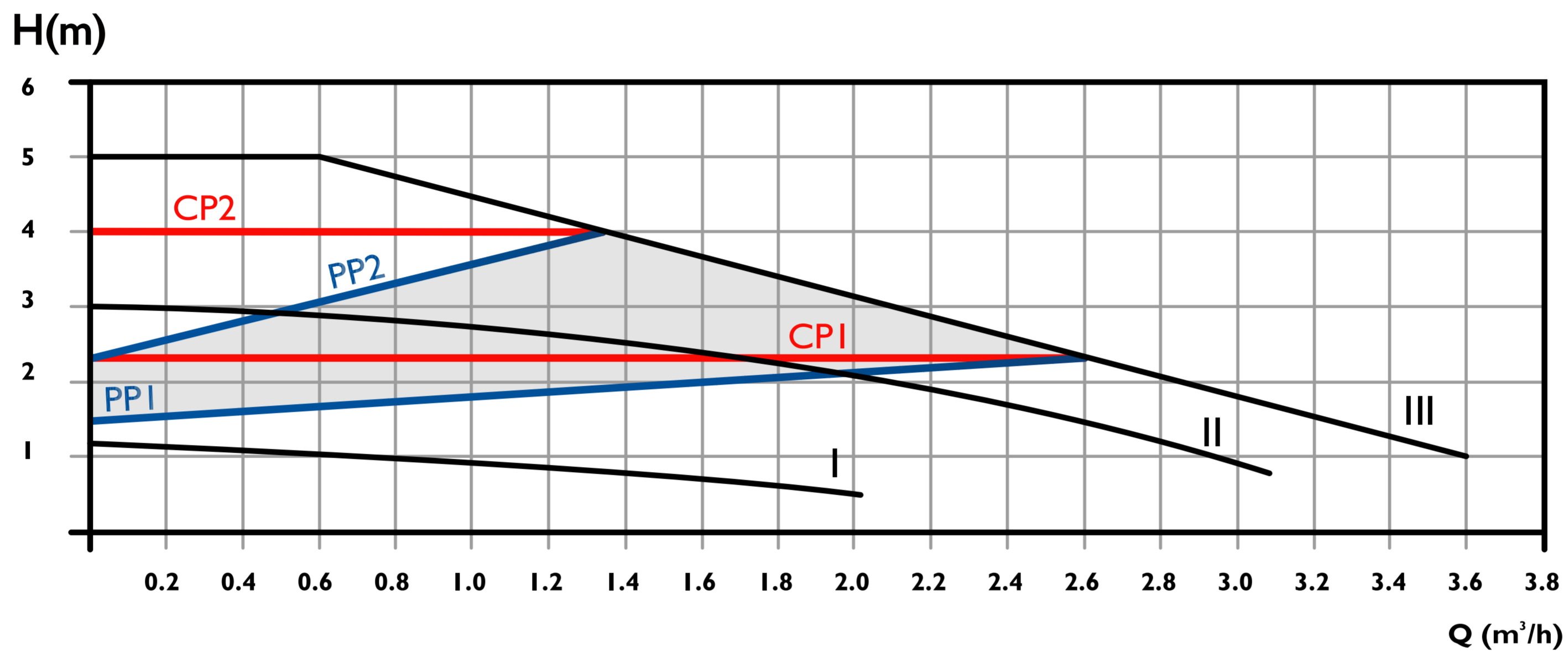

P5 32/5

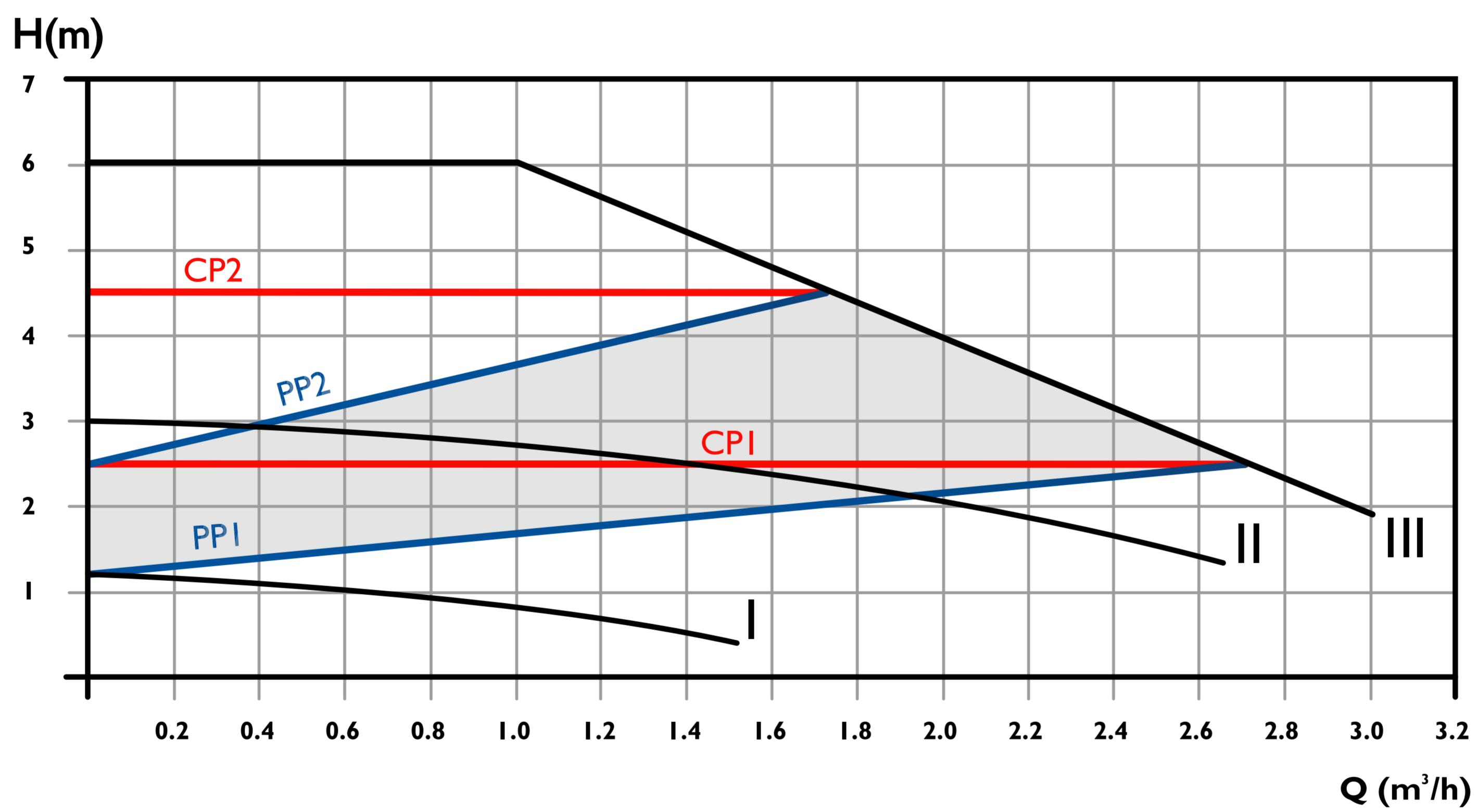

P5 15/6

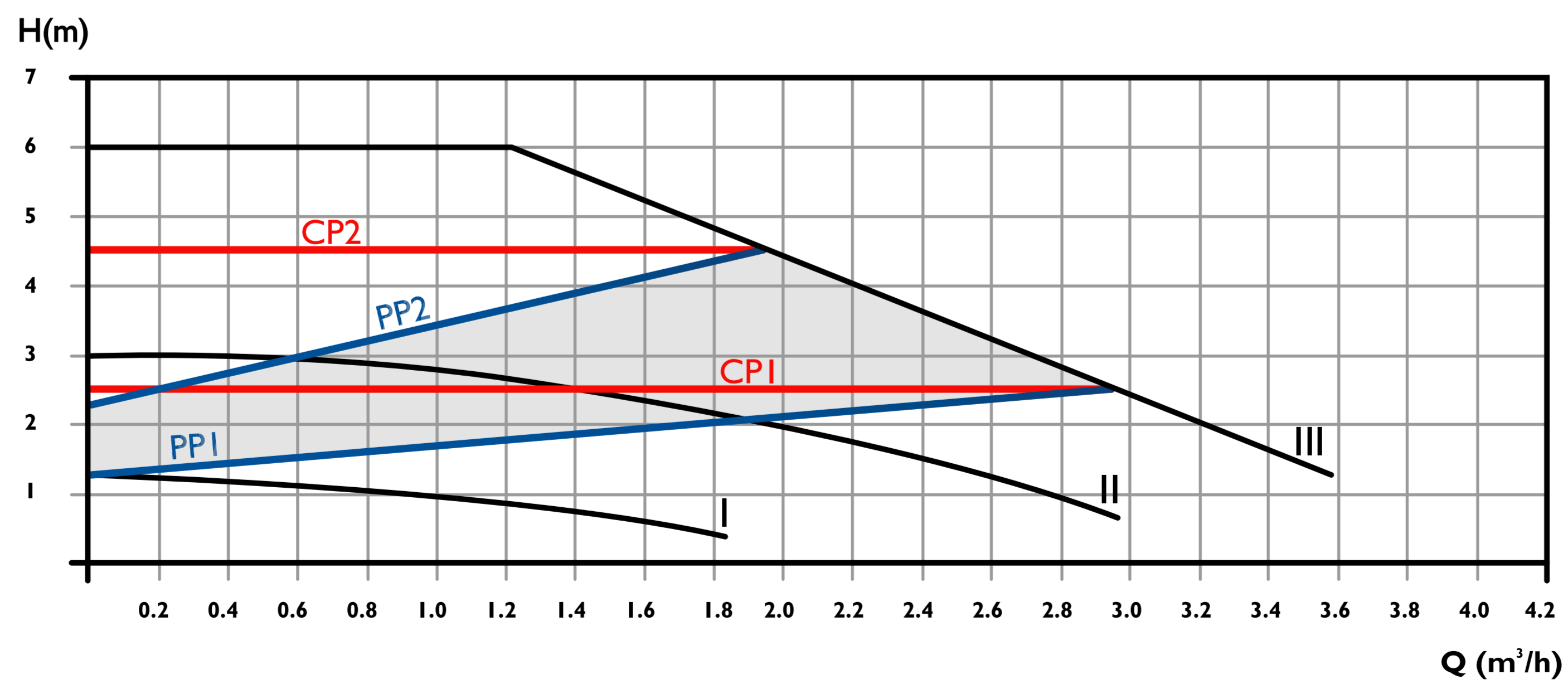

P5 25/6

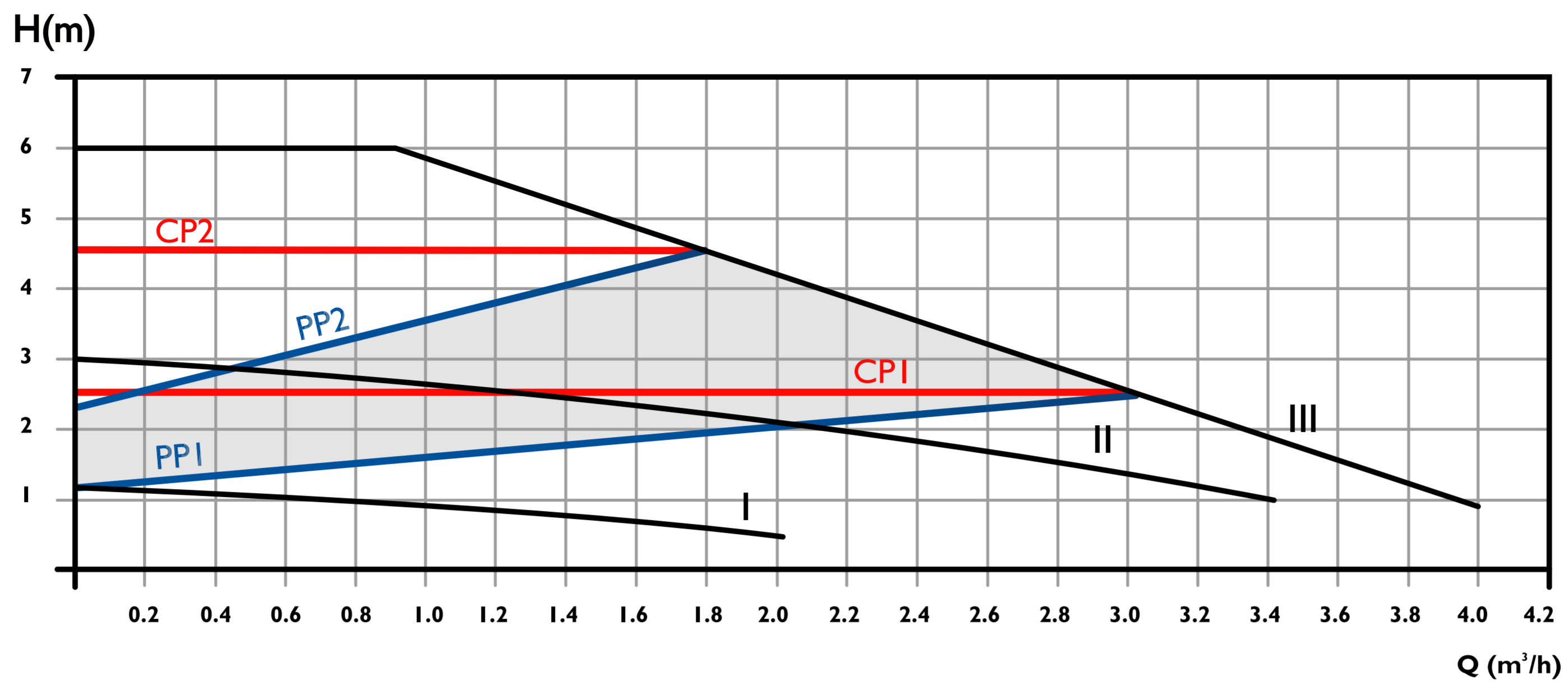

P5 32/6

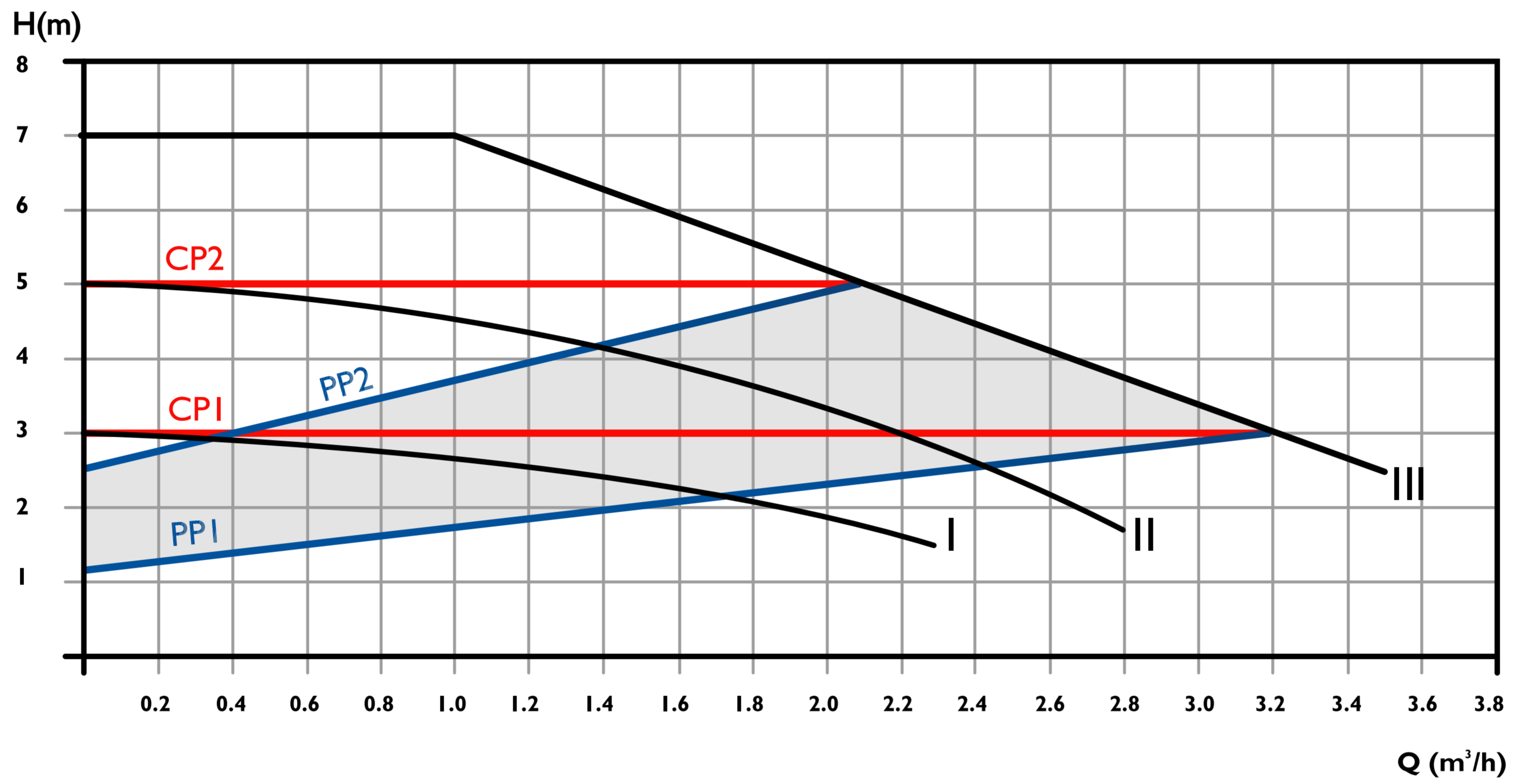

P5 15/7

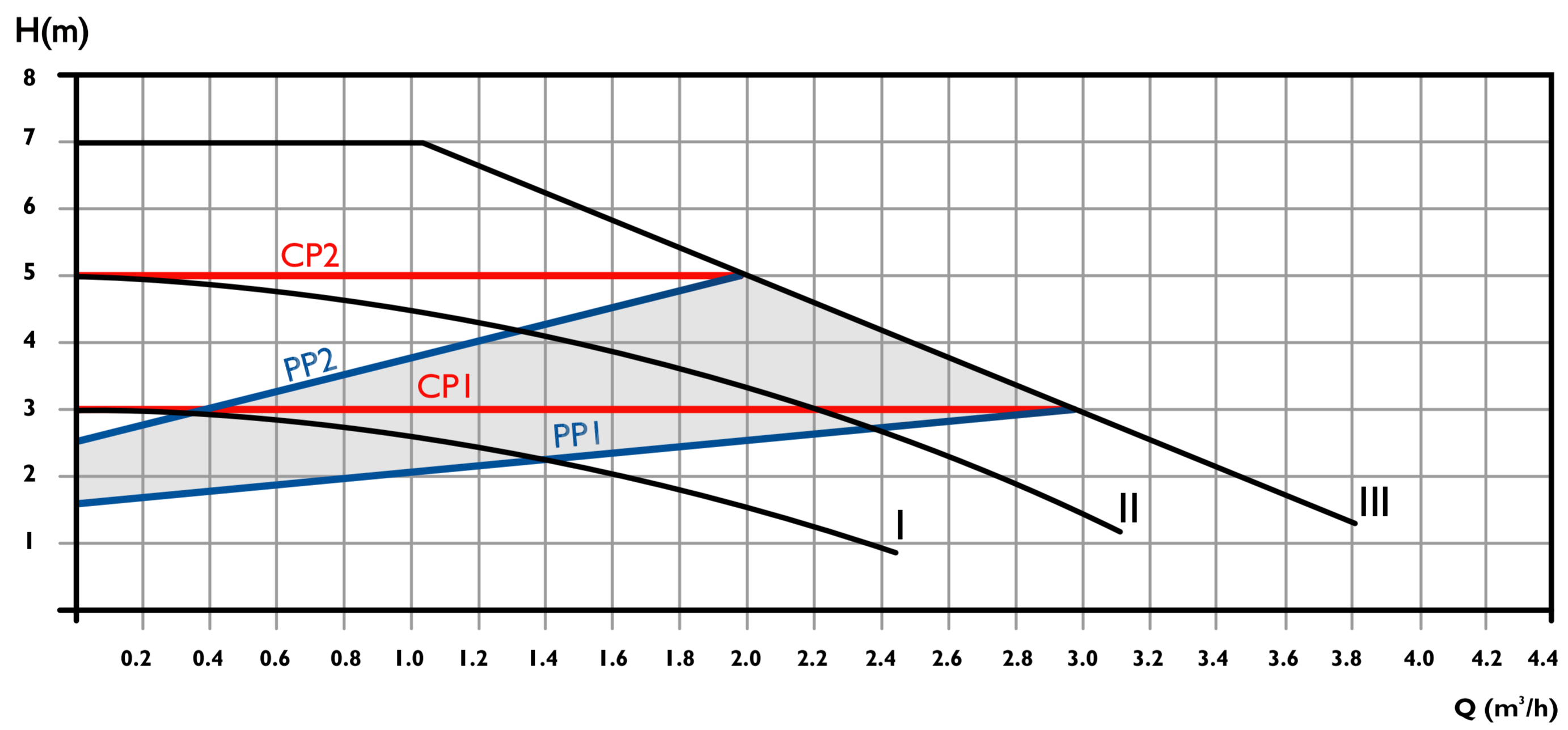

P5 25/7

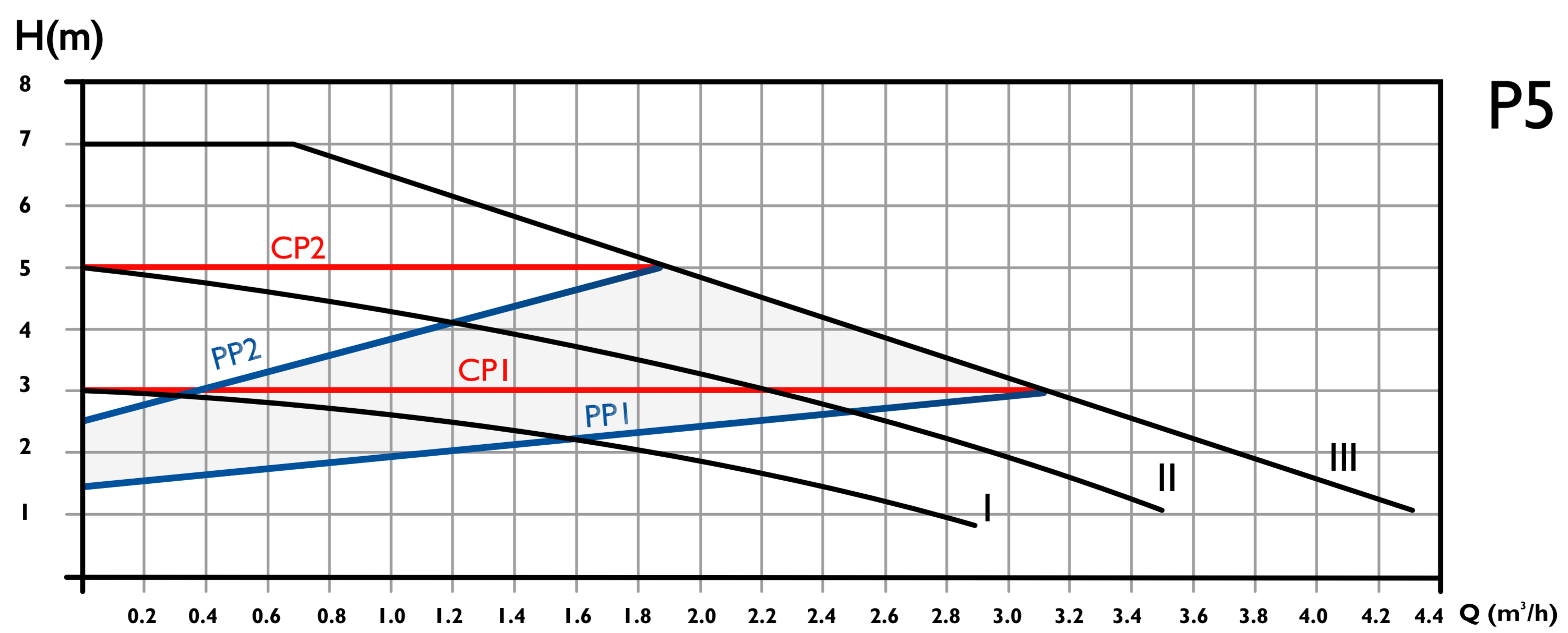

P5 32/7



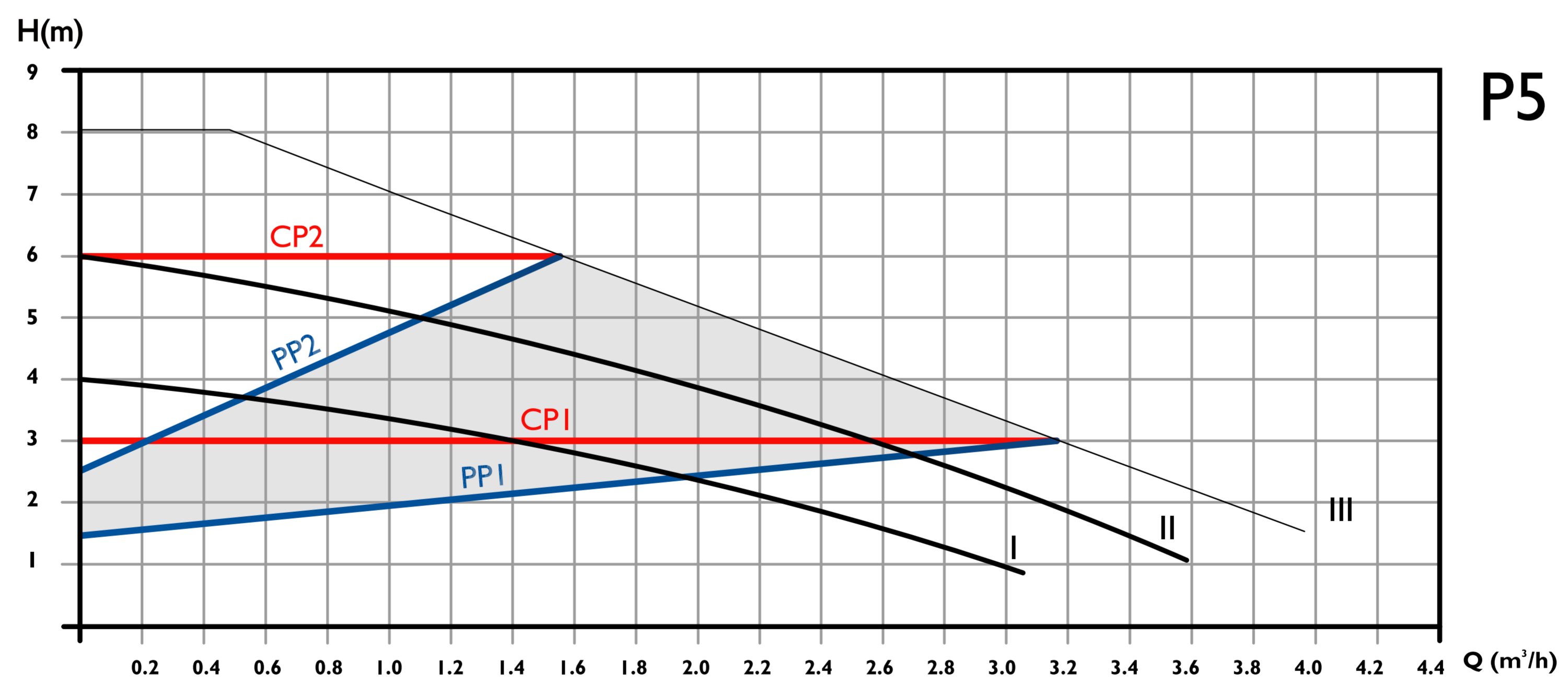
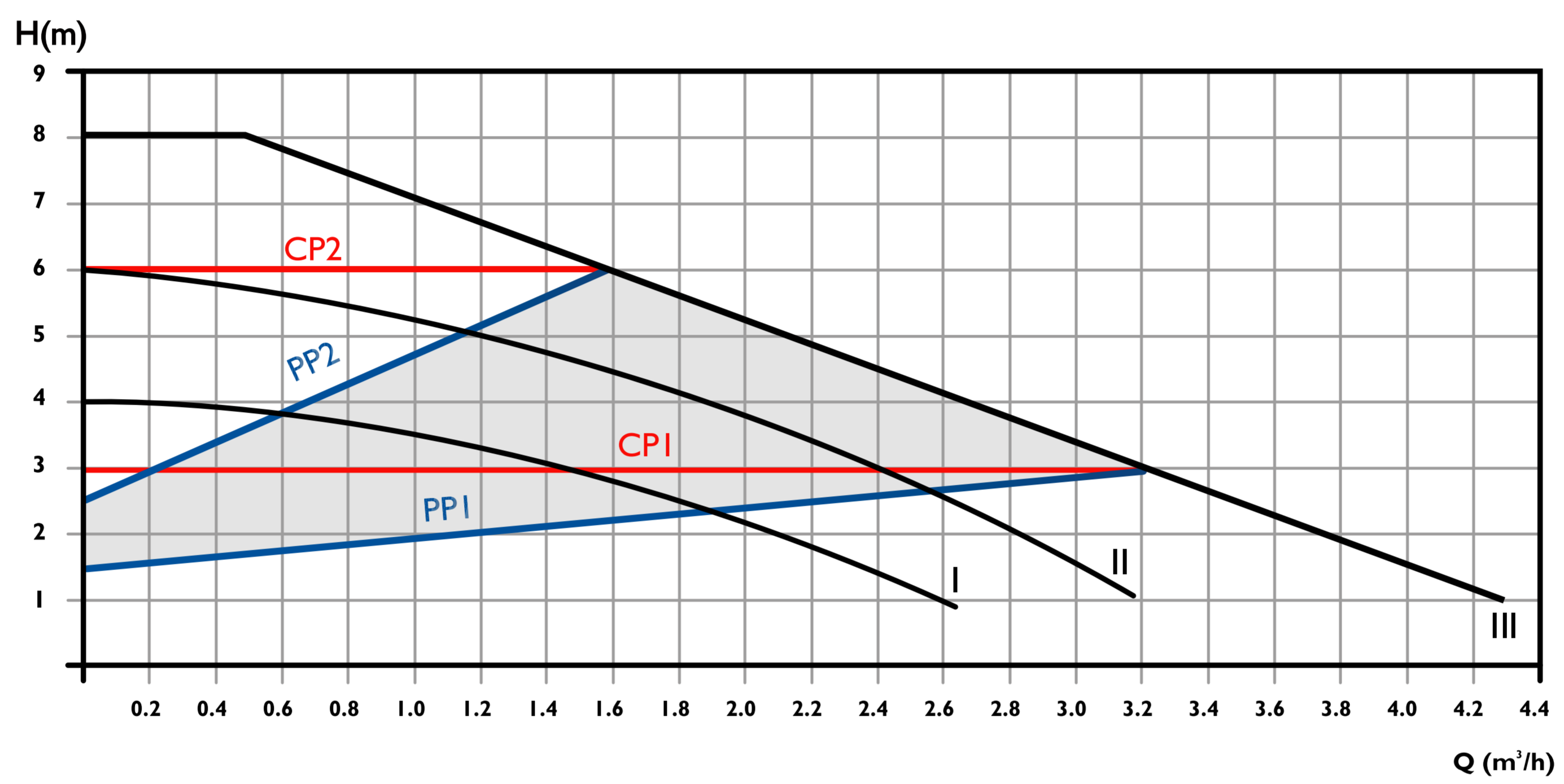
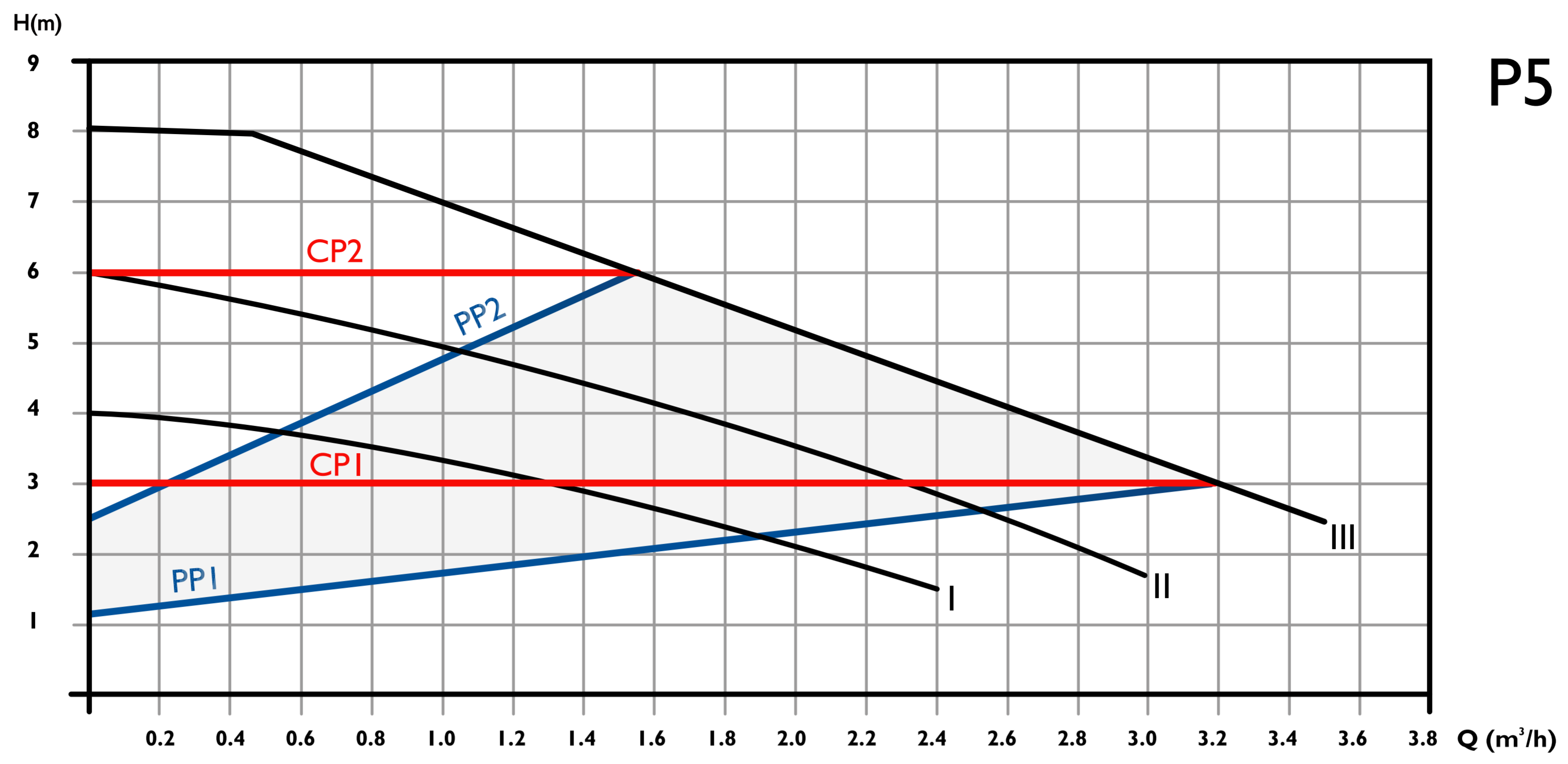

## APPENDIX 2

### MALFUNCTIONS



The pump is an engineering equipment in which the electrical part (motor) and the pumping part, where the fluid is pumped, are combined. Therefore, when performing any work, it is necessary to follow the rules of electrical safety. Be sure to turn off the power before doing any work. Make sure that fluid does not enter inside the terminal box and electrical cables, plugs, sockets, etc.



If you find any malfunctions or failures, we recommend you to contact the engineer who installed the pump first and then Brittherm Limited by 0208 9044 832 or email [info@brittherm.co.uk](mailto:info@brittherm.co.uk)

Possible malfunctions and elimination methods:

### TROUBLE SHOOTING

Error Code	Protection type	Likely causes	What to do
<b>E1</b>	Locked-rotor protection	Pump rotor is blocked	Disassemble the motor and check if the rotor can rotate normally. If not, clean up the impurities inside the rotor.
<b>E2</b>	Open phase protection	One or more phases of the internal connection circuit is disconnected	Replace the pump
<b>E4</b>	Over-current protection by hardware	Short circuit of internal connection circuit	Replace the pump
<b>E5</b>	Over-current protection by software	Short circuit of internal connection circuit	Replace the pump

# WARRANTY

## P5 SERIES PUMP WARRANTY INFORMATION

Your P5 Series Pump comes with a 6-year warranty against manufacturing defects.

This warranty ensures peace of mind and protection for your investment, provided the following conditions are met:

**CORRECT INSTALLATION:** The pump must be installed by a qualified engineer according to BritTherm's installation manual.

**PROPER MAINTENANCE:** The system must be maintained in line with BritTherm maintenance guidelines.

**WARRANTY REGISTRATION:** The warranty must be registered within 30 days of purchase at [www.brittherm.co.uk/guarantees](http://www.brittherm.co.uk/guarantees). Incorrect or incomplete registration will void the warranty.

### WARRANTY CLAIMS PROCEDURE

In the unlikely event of a manufacturing fault, you can make a warranty claim.

Please provide the following information:

- The unique warranty registration code received during registration.
- A copy of the pump purchase invoice.
- Additional evidence such as photos or videos may be requested to facilitate the claim process.

Send all claims to [warehouse@brittherm.co.uk](mailto:warehouse@brittherm.co.uk). Once your claim is validated, BritTherm will provide a replacement pump free of charge.

Please note, BritTherm does not offer repairs under this warranty.

### EXCLUSIONS AND LIMITATIONS

The warranty does not cover:

- Malfunctions due to incorrect installation, inadequate maintenance, or the use of inappropriate liquids (e.g., those containing solid particles, fibres, or mineral oil).
- Damage caused by improper use, storage, or maintenance.
- Labour costs for pump removal or reinstallation.
- For full terms and conditions, visit our website at [www.brittherm.co.uk/guarantees](http://www.brittherm.co.uk/guarantees).

**BRITTHERM™ IS PROUD TO SUPPLY THE UK'S LONGEST-LASTING CENTRAL HEATING PUMPS, WITH FAST DELIVERY AND COMPETITIVE PRICING.**

THANK YOU FOR CHOOSING BRITTHERM!

